



WELLNESS ATTITUDE

fima | CARLO FRATTINI®
rubinetterie

WELLNESS ATTITUDE

#GREEN

FIMA CARLO FRATTINI da anni evolve i propri processi produttivi finalizzandoli ad una costante riduzione di risorse, materiali ed energia ed operando un controllo costante sulle materie prime, sui consumi e sull'impatto ambientale di tutte le fasi di produzione e commercializzazione dei propri prodotti.

Un'azienda eco sostenibile, alimentata da energia auto-prodotta e in grado di realizzare prodotti sicuri per la salute e per l'ambiente con un basso impatto ambientale.

FIMA CARLO FRATTINI has been for many years constantly developing its production processes in order to reduce the use of resources, materials and energy. Furthermore, all FIMA Carlo Frattini projects are developed considering all the steps of a product's life, from its manufacturing to the shipment till its dismantlement.

An environmentally friendly company, powered by self-produced electricity and able to produce products safe for human health and the environment with a very low environmental impact.

#QUALITY

I migliori materiali e tecnologie all'avanguardia per garantire un utilizzo quotidiano impassibile al trascorrere del tempo. Fima Carlo Frattini sposa un approccio globale alla qualità che deriva da un'attenzione all'innovazione tecnologica, adottando processi industriali all'avanguardia, scegliendo le migliori materie prime. Tutti i prodotti vengono sottoposti a minuziosi e severi controlli in ogni fase di lavorazione e sono progettati in modo da rispettare tutte le più rigide normative internazionali. Ulteriore testimonianza di questa filosofia improntata alla qualità totale è la garanzia che si estende per ben 7 anni su tutta la produzione.

Best materials and cutting-edge technologies as a guarantee for an everyday use unchanging over time. FIMA Carlo Frattini follows a global approach to quality coming from a particular attention to technology innovation, by adopting cutting-edge industrial processes, choosing the best raw materials. Detailed strict controls are carried out on all the products in every production phase and all the items are designed in order to respect the most stringent international regulations. Its seven-year extended warranty on all the product is a further evidence of this philosophy based on total quality.

#DESIGN

Prodotti unici nel loro genere, studiati per massimizzare il comfort di utilizzo e con un inconfondibile tocco Made in Italy. Convinta del potere della creatività, del design e delle nuove tecnologie, l'Azienda ha assunto negli anni un taglio innovativo e in continua evoluzione. Questo atteggiamento l'ha portata a interpretare e anticipare le esigenze presenti e future del mercato, proponendo prodotti all'avanguardia per design e tecnologia. Studiati per massimizzare il comfort di utilizzo e caratterizzati da uno stile unico sono progettati da nomi noti del design.

One-of-a-kind products, designed to maximize the comfort in use with an unmistakable hint of Made in Italy. The Company, firmly confident of the power of creativity, design, and new technologies, has developed over the years innovative and ever-changing traits. This approach has led it to interpret and anticipate the current and future market needs, by proposing state-of-the-art products in terms of design and technology. Designed to maximize the comfort in use and characterised by a unique style, all the items are designed by well-known designers.





Acqua e benessere.
Un connubio che ci ha spinto
ad immaginare per voi
un percorso fatto di gesti,
emozioni e poesia,
per guidarvi alla costruzione
del vostro personale momento
di Wellness.

WELLNESS ATTITUDE

Water and wellness.
A combination that
inspires us to imagine path
made of gestures
emotions and poetry,
to guide us in the construction
of our personal
moment of Wellness.





libertà

- (ant. *libertate* e *libertade*)s. f. [dal lat. *libertas* -atis].
- 1. a. L'esser libero, lo stato di chi è libero

Prendere un tempo imprecisato solo per noi, un tempo per staccare da tutto e da tutti. Fermarsi. Prendersi un momento prima di fare qualunque cosa. Per apprezzare e godersi la sola sensazione di essersi fermati.

Take some time just for yourself, time to get away from it all. Stop. Take a moment before everything else. To appreciate and enjoy that single sensation of being still.

UNA PERSONAL SPA NATA DALLA SINERGIA DI ACQUA E CROMOTERAPIA

A personal spa designed on the
synergy of water and chromotherapy

Modular crea un vero e proprio percorso benessere. Composto da 5 moduli differenti, abbinabili tra loro a seconda delle diverse esigenze, dà vita a un autentico momento rilassante sotto la doccia amplificato dall'esperienza sensoriale della cromoterapia.

Modular creates a real path to wellness. Composed of 5 different modules, combined according to various needs, it develops an authentic, relaxing moment under the shower enhanced by the sensory experience of chromotherapy.





UN SOFFIONE COMPONIBILE PER SODDISFARE OGNI ESIGENZA PROGETTUALE

A combined shower head to meet every
design need

I diversi moduli si compongono abbinando getti differenti (Rain, Cascata, Nebulizzante) a Rain con Cromoterapia ed Entertainment con luci e musica. Poliedriche sensazioni in una scenografia avvolgente e inebriante.

The various modules are composed by combining different jets (Rain, Cascade, Mist Spray) to Rain with Chromotherapy and Entertainment with lights and music. Versatile sensations in a captivating and enlivening design.

*Nell'immagine di sinistra
soffione Modular in funzione in
versione rain.*

*In questa pagina Modular in
funzione in versione cascata e
Rain.*

*The image on the left shows the
Modular shower head running
in the Rain version.*

*On this page, Modular is
running in the Cascade and
Rain version.*





scenografia

- s. f. [dal lat. *scaenographĭa*, gr. *σκηνογραφία*, comp. di *σκηνή* «scena» e *-γραφία* «-grafia»]. – 1. Arte e tecnica di creare

L'ambiente bagno si trasforma. Gli elementi disposti al suo interno regalano pace e serenità preparando la mente a concedersi un momento di relax. Le luci sono soffuse, allontanano ogni pensiero. Il flusso e il rumore dell'acqua avvolgono, liberano la mente.

Bathroom surroundings are transformed. The elements arranged within present peace and calm, preparing and granting the mind a moment of relaxation. Lighting is dimmed, far from thoughts. The captivating flow and sound of the water, solace the mind.



*Nell'immagine di sinistra
soffione Melograno in
funzione. Sullo sfondo
Showerbox con parti esterne
in finitura nickel spazzolato.
In dettaglio ampolle in vetro
soffiato satinato.*

*The image on the left shows
the Melograno shower head
running. The Showerbox
background with external
parts in brushed nickel finish.
In detail, satin blown glass
ampoules*

LA FORZA DELL'ACQUA UNITA ALLA POTENZA DELLA LUCE

The strength of water with the power of light



Dieci sfere satiniate in vetro soffiato, che evocano la forma di una goccia d'acqua, fluttuano sospese a diverse altezze all'interno dell'ambiente doccia creando uno spazio in cui la potenza della luce si unisce alla forza dell'acqua.

Suggestivi riflessi e intriganti giochi di luce regalano un'esperienza a tutto tondo e nuovi punti di vista. Melograno è un soffione che va oltre l'estetica e la funzione, diventando simbolo di nuove forme ed espressioni del vivere la stanza dell'acqua. Un'esperienza unica e totalmente immersiva in cui lasciarsi trasportare completamente dalla forza della natura.

Ten smoky spheres of blown glass, kindle the shape of a drop of water, floating suspended at different heights inside the shower to create a space, whose power of light merges with the force of water.

Charming reflections and intriguing light effects gives an all-round experience and new thoughts of vision. Melograno is a shower head that goes beyond aesthetic and function, becoming a symbol of new shapes and expressions of experiencing the water like never before.



rituale

- agg. e s. m. [dal lat. *ritualis*, der. di *ritus* -us «rito»].
- 1. agg. a. Che appartiene al rito

I pensieri rallentano, sei pronto a prenderti il tuo tempo.
Sai già cosa devi fare.

Rilassarti nel tuo bagno non è solo fare una doccia
ma ricreare un ambiente fatto di luci, suoni e profumi.
Il calore e la delicatezza dei getti d'acqua faranno il
resto.

Slower thoughts, you are ready to take your time. You
know what you have to do.

Relaxing in your bathroom is not only taking a shower,
but recreating an ambient made of light, sounds and
scents. The heat and delicacy of the water jets do the
rest.



NUOVA DIMENSIONE DI BENESSERE

A new dimension of wellbeing

Still è un soffione dal design minimale e all'avanguardia con un concept semplice e lineare, le cui forme pulite ed essenziali esaltano il naturale movimento dell'acqua.

I suoi tre aeratori orientabili singolarmente a piacere assicurano grandi performance di erogazione e consentono di vivere un'esperienza doccia memorabile e avvolgente, garantendo un ridotto consumo idrico.

La soluzione ideale per riscoprire e vivere i benefici dell'acqua attraverso i suoni e le sensazioni sulla pelle.

Still is a shower head with minimal, state of the art design with a simple and linear concept, whose clean and essential lines emphasise the natural movement of the water.

Its three aerators can be individually adjusted to suit you, ensuring utmost delivery performance and allow you to experience a memorable and captivating shower, guaranteeing reduced water consumption.

The ideal solution to rediscover the benefits of water through sound and the sensations of the skin.

UN PICCOLO PULSANTE, GRANDI FUNZIONALITÀ

A small button, huge functionality

Un semplice gesto, un tocco leggero che aziona il flusso dell'acqua in corrispondenza dell'uscita stessa. Un flusso abbondante per una piacevole sensazione di benessere.

Con Switch è possibile costruire il proprio sistema con la massima libertà compositiva e spaziale scegliendo tra diverse uscite in grado di alimentare indipendentemente o contemporaneamente vari sistemi per creare il proprio rituale doccia.

Tre le versioni disponibili - a incasso, a mensola e a colonna - che rispondono a differenti esigenze progettuali, funzionali e stilistiche.

A simple gesture, a light touch that activates the water flow on the same outlet. An abundant flow for a pleasant sensation of wellness.

Switch allows you to build your own system with utmost freedom in terms of composition and space, choosing from various outlets to independently or simultaneously power various systems to create your own showering ritual.

Among the versions available - built-in, shelf and column - to meet different design, functionality and style needs.

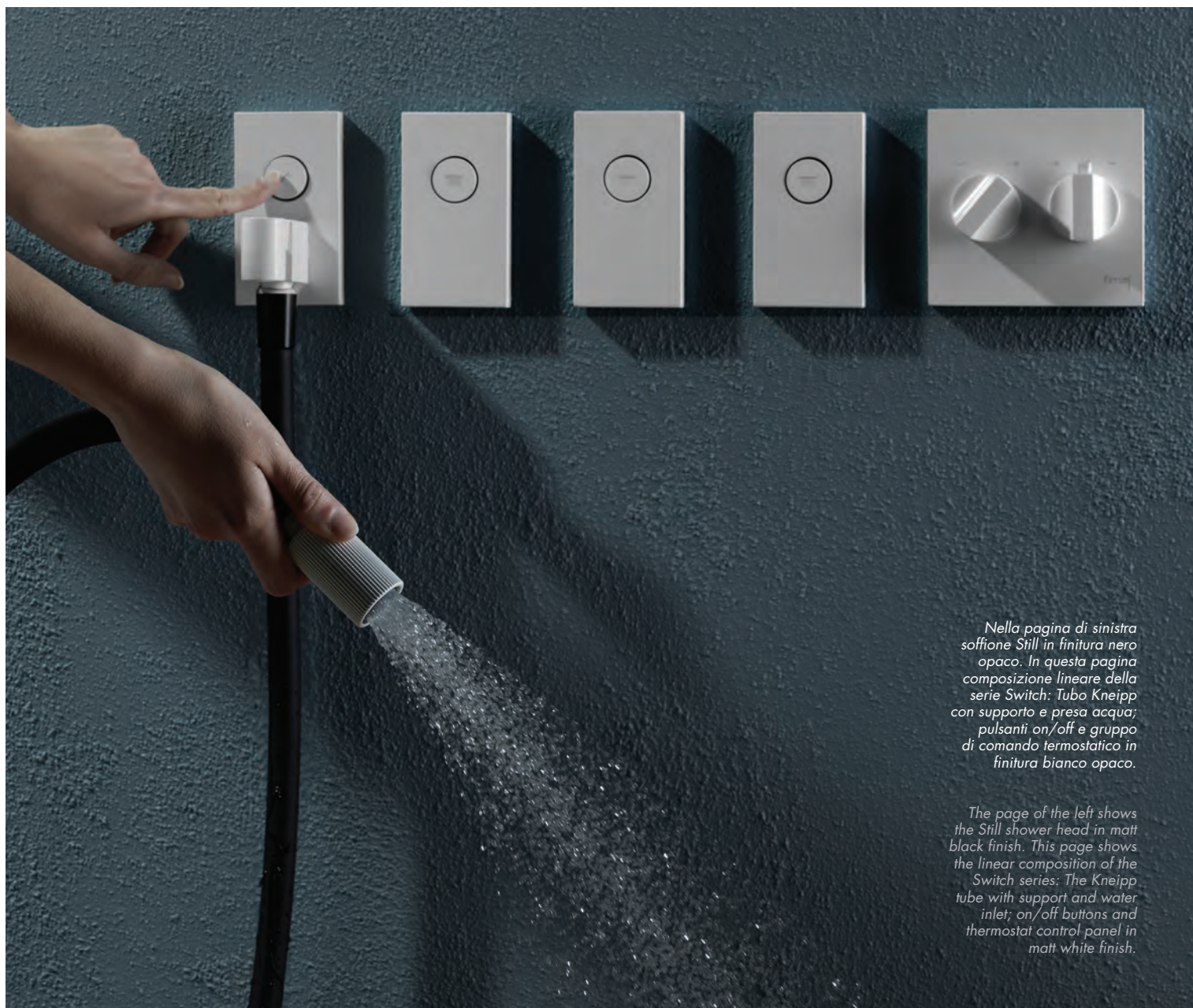

*Nella pagina di sinistra
soffione Still in finitura nero
opaco. In questa pagina
composizione lineare della
serie Switch: Tubo Kneipp
con supporto e presa acqua;
pulsanti on/off e gruppo
di comando termostatico in
finitura bianco opaco.*

*The page of the left shows
the Still shower head in matt
black finish. This page shows
the linear composition of the
Switch series: The Kneipp
tube with support and water
inlet; on/off buttons and
thermostat control panel in
matt white finish.*



sensazione

s. f. [dal lat. tardo *sensatio* -onis, der. di *sensus* -us «senso»] – 1.
Ogni stato di coscienza in quanto sia avvertito come prodotto da uno stimolo esterno o interno al soggetto

Il rumore dell'acqua fruscante dai toni caldi e dal calore inebriante. La giusta temperatura per avvolgerti e accoglierti. Nuove sensazioni che ti conducono in una nuova piacevole e diversa atmosfera.

The noise of rustling water with warm tones, sets the right mood. The right temperature to invite and captivate you. New sensations that lead you into a new, pleasant and diverse atmosphere.



RIFLETTORI PUNTATI SULLA PERSONALIZZAZIONE DEL BENESSERE

Spotlight on the customization of wellness

Tre diversi getti per tre differenti esperienze. Grazie al soffione O3 la mente alterna sensazioni diverse in un percorso rigenerativo fatto di momenti: laminare, un getto trasparente e delicato che, a contatto con il corpo, regala una gradevole sensazione rigenerante; rain, un ampio flusso di acqua creato da una pioggia morbida e avvolgente; cascata, un flusso veloce e deciso offre un massaggio energizzante e vigoroso. Un percorso SPA da rivivere ogni giorno.

Three different sprays for three different experiences. Thanks to the O3 shower head, the mind alternates between different sensations in a regenerative path composed of moments: laminar, a transparent and delicate jet which, in contact with the body, gives a pleasant sensation of regeneration; rain, an ample flow of water created by soft and captivating rain; cascade, a fast and decisive flow offers an energising and vigorous massage.

A reviving SPA experience day after day.





Nella pagina a fianco da sinistra getto laminare, getto rain e getto cascata in cromo. In questa pagina i tre soffioni O3 in finitura bianco opaco.

This page, to the side on the left, shows the laminar jet, the rain jet and the cascade jet in chrome. This page shows three O3 shower heads in matt white finish.

energia

s. f. [dal lat. tardo energĭa, gr. ἐνέργεια, der. di ἐνεργής «attivo», da ἔργον «opera»]. – 1. a. Vigore fisico, spec. dei nervi e dei muscoli, potenza attiva dell'organismo

L'acqua dona al corpo nuova energia. Il vigore dei getti ci risveglia dal torpore iniziale. Il flusso dell'acqua aumenta e diminuisce a proprio piacere con un semplice gesto. A tratti delicato, a tratti energico. Il corpo si rigenera e ci fa sentire vivi.

Water gives new energy to you. The vigour of the jets reawaken us from that initial numbness. The flow of water increases and decreases to suit you with a simple gesture. At times gentle, other times energetic. The body regenerates to make us feel alive.







UN SOFFIONE MULTIFUNZIONE CHE TRASFORMA IL BAGNO IN UNA VERA E PROPRIA SPA

A multi-functional shower head that
transforms your bathroom into a real and
genuine spa



La forza dell'ampio getto d'acqua dà la sensazione di immergersi in un'esperienza che evoca le piacevoli piogge della stagione estiva.

La possibilità di giocare con diverse quantità d'acqua e tipologie di getti permette di sperimentare differenti sensazioni in uno stesso momento: otto getti d'acqua nebulizzata, i morbidi e delicati raining jet e la lama a cascata che converge al centro per un risultato vitalizzante. Harmonia è dotata anche di una luce led in 8 differenti colorazioni che aggiunge alle emozioni dell'acqua quelle della cromoterapia, creando suggestive atmosfere e aumentando la sensazione di benessere.

The force of an ample water jet gives the sensation of immersion in an experience that evokes pleasant summer rain.

The possibility of playing with different quantities of water and the types of jets allow experimentation with different sensations at the same time; eight water jet sprays, soft and delicate raining jets and the cascade blade that converge in the centre for a vitalising result. Harmonia is also equipped with 8 different led colours that enhance the emotions of the water with those of chromotherapy, creating a suggestive atmosphere and increasing the sensation of wellness.

*In questa pagina
soffione Harmonia
95x95cm con quattro
getti pioggia, due getti
cascata e otto getti di
acqua nebulizzata.*

*This page shows the
Harmonia 95x95cm
shower head with four
rain jets, two cascade
jets and eight sprayed
water jets.*



intensità

s. f. [der. di intenso]. Più spesso in senso relativo, il grado di forza o la violenza con cui si produce o manifesta un fenomeno, una sensazione, un sentimento.



Un getto energico e limpido che purifica corpo e mente. Le sensazioni che variano a seconda degli stimoli del flusso dell'acqua. Chiudere gli occhi e sentire il proprio battito: costante, intenso.

A vigorous, limpid jet to purify body and mind. Varying sensations according to the stimuli of the water flow. Close your eyes and feel your heartbeat: constant, intense.



SUONI E SENSAZIONI DA TOCCARE CON MANO

Sounds and sensations you
can touch

I differenti getti della divisione Wellness cambiano il modo di concepire la doccia. Getti energici declinati in differenti forme: pioggia morbida sotto cui lasciarsi trasportare dalle proprie emozioni; getto laminare piacevole che dà una sensazione rigenerante come nelle vere Spa; cascate vigorose sotto cui chiudere gli occhi e godersi un massaggio naturale.

Diversi getti, diversi suoni... un'armonia nell'ambiente bagno che risveglia i sensi e offre una sensazione di benessere.

The different jets of the Wellness division change the shower concept. Vigorous jets available in different ways: soft rain under which you allow yourself to be transported by your emotions; the laminar jet, pleasant and giving a regenerative sensation, just like a real Spa; vigorous cascades under which you can close your eyes and enjoy a natural massage.

Different jets, different sounds... the harmony of bathroom surroundings that reawakens the senses and offers a sensation of wellness.



A sinistra getto laminare serie Harmonia. In alto getto rain serie Still e a destra il getto rain della doccetta Switch.

On the left, the laminar jet from the Harmonia series. At the top, the rain jet from the Still series. On the right, the rain jet with Switch hand shower.



equilibrio

s. m. [dal lat. aequilibrium, comp. di aequus «uguale» e libra «bilancia»]. – 1. Stato di quiete di un corpo

Il corpo raggiunge il proprio equilibrio.
Getti d'acqua delicati e temperatura tiepida dell'acqua ci riportano gradualmente alla normalità. La mente vaga, ripercorre le sensazioni appena vissute mentre ci prepariamo ad uscire dal nostro spazio wellness.

Your body achieves the right balance.
Delicate water jets and the lukewarm temperature of the water gradually bring us back to normality. The mind wanders, retracing the sensations just experienced, while we prepare to leave our wellness area.

*In questa pagina
dettaglio del getto.
Nella pagina a fianco il
soffione Sfera in finitura
bianco opaco nella
versione a parete.*

*This page shows the
jet detail. The page
alongside shows the
Sfera shower head with
a matt white finish in the
wall-mounted version.*



LA DELICATEZZA RACCHIUSA IN UNA SFERA

Delicacy enclosed in a sphere

Elegante nella sua forma ed estremamente funzionale. Una vera e propria sfera, caratterizzata da due "tagli": il primo consente di nascondere tutti gli elementi tecnici e il secondo modella la superficie di emissione dell'acqua. Un getto d'acqua morbido e avvolgente in grado di regalare sensazioni di benessere.

Elegant shape and extremely functional. A real and proper sphere, characterised by two "cuts". the first conceals all the technical elements and the second models the water emission surface. A soft and inviting water spray capable of giving sensations of wellness.





emozione

s. f. [dal fr. *émotion*, der. di *émouvoir* «mettere in movimento» sul modello dell'ant. *motion*]. – Impressione viva, turbamento, eccitazione

Il corpo è rilassato e rigenerato. La mente è vuota, si concede ancora qualche attimo di completo ozio. Prendetevi ancora qualche momento prima di fare qualunque cosa. Per apprezzare e godervi la sensazione di esservi fermati.

Your body is relaxed and regenerated. Your mind becomes free, granting a little more absolute leisure time. Take a moment more, before all else. To appreciate and enjoy the sensation of being still.



ABBINAMENTI CROMATICI E MATERICI PER STIMOLARE I SENSI

Colour and material combinations to
stimulate the senses

SCENOGRAFIE CONTEMPORANEE PER UN SOFFIONE CUSTOMIZZABILE AD HOC

Contemporary design
For an ad hoc personalisable
shower head

Moove porta nell'ambiente bagno scenografie e relax personalizzato grazie ai molteplici livelli di customizzazione. E' possibile costruire ad hoc il proprio soffione scegliendo le modalità di installazione - sospesa o a muro - le varie configurazioni dei moduli - una lama, un soffione, la combinazione di due soffioni, due lame oppure di una lama e un soffione - e le finiture del telaio e dei moduli per personalizzare la propria esperienza doccia. In particolare la versione con il telaio in vetro temperato, materiale inedito per un soffione, crea un'architettura invisibile e leggera che fluttuando all'interno dello spazio doccia si carica di una straordinaria valenza scenografica.

Moove allows the bathroom a relaxing, personalisable setting thanks to the multiple customisable levels. Your shower head can be built ad hoc by choosing the installation method - suspended or wall-mounted - the various module configurations - blade, shower head, the combination of two shower heads, two blades or a blade and a shower head - and the finishes of the frame and the modules to customise your shower experiences. In particular, the version with the frame in tempered glass, a novel material for shower heads, creates invisible and light architecture that fluctuates inside a shower space for an extraordinary setting.

*A sinistra soffione
Moove sospeso in vetro
temperato con moduli
pioggia e cascata.
In basso miscelatore
termostatico della serie
So a quattro uscite in
finitura nero opaco con
maniglie in legno scuro.*

*On the left, the
suspended Moove
shower head in tempered
glass with rain and
cascade modules. At the
bottom, the So series
thermostatic mixer with
four outlets in a matt
black finish with dark
wood handles.*







composizione

*s. f. [dal fr. émotion, der. di émouvoir «mettere in movimento»
sul modello dell'ant. motion].
– Impressione viva, turbamento, eccitazione*

Molteplici possibilità di composizioni e allestimenti grazie all'ampia gamma di soffioni e complementi disponibili nella divisione Wellness.

Many possible configurations and layouts thanks to the wide range of shower items available in the wellness section.

SWITCH

DAVIDE VERCELLI DESIGN

FINITURA
FINISHING



VERSIONE
VERSION

CODICE
CODE

DIMENSIONE
SIZE

	F5921	112 x 121 mm	
	F5922	112 x 62 mm	
	F5923	112 x 62 mm	
	F5924	112 x 62 mm	
	F5924/1	112 x 62 mm	
	F5925	112 x 62 mm	
	F5926	112 x 62 mm	
	F5927	Ø 30 mm	
	F5928	Ø 30 mm	
	F5980/1		
	F5980/2		
	F5980/3		
	F5980/4		
	F5980/5		
	F5980/6		





MELOGRANO

DAVIDE VERCELLI DESIGN

Soffione a soffitto Melograno

Ceiling mounted showerhead Melograno

FINITURA
FINISHINGVERSIONE
VERSIONCODICE
CODE

F2997

DIMENSIONE
SIZE

500 x 745 mm



○3

DAVIDE VERCELLI DESIGN

Soffione a parete
O3 showerhead



FINITURA
FINISHING



VERSIONE
VERSION

CODICE
CODE

DIMENSIONE
SIZE



F5914

190 x 150 mm



F5915

190 x 150 mm



F5916

190 x 150 mm



F5918

106 x 150 mm



F5919

106 x 150 mm



F5920

106 x 150 mm



STILL

DAVIDE VERCELLI DESIGN

Soffione Still
Still showerhead



FINITURA
FINISHING



VERSIONE
VERSION



CODICE
CODE

F5912

DIMENSIONE
SIZE

482 x 30 mm



SFERA

MENEGHELLO PAOLELLI DESIGN

Soffione Sfera in ottone
Sfera showerhead



FINITURA
FINISHING



VERSIONE
VERSION



CODICE
CODE

F2340

DIMENSIONE
SIZE

225 x 240 mm



F2340/1

180 x 240 mm



NU

DAVIDE VERCELLI DESIGN

Soffione Nu
Nu showerheadFINITURA
FINISHING

CR

VERSIONE
VERSIONCODICE
CODEDIMENSIONE
SIZE**F2850**

600 x 270 mm

**F2855**

610 x 180 mm

**F2860**

600 x 180 mm



MOOVE

DAVIDE VERCELLI DESIGN

Soffione con telaio in acciaio inox
Showerhead with frame in stainless steel





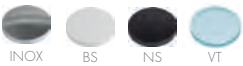





















FINITURA
FINISHING



VERSIONE
VERSION

CODICE
CODE

DIMENSIONE
SIZE

	F2991B	616 x 261 mm		
	F2991N	616 x 261 mm		
	F2991S	616 x 261 mm		
	F2992B	616 x 261 mm	 	
	F2992N	616 x 261 mm	 	
	F2992S	616 x 261 mm	 	
	F2993B	616 x 266 mm		
	F2993N	616 x 266 mm		
	F2993S	616 x 266 mm		
	F2993VT	616 x 266 mm		



F2994

Modulo a pioggia aggiuntivo per F2993
Additional rain flow module for F2993

FINITURA
FINISHING

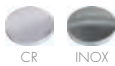

F2995

Modulo a cascata aggiuntivo per F2993
Additional cascade flow module for F2993

FINITURA
FINISHING

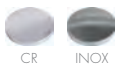

MODULAR

CENTRO RICERCA FIMA DESIGN

Soffione Modular
Modular showerhead



FINITURA
FINISHING



VERSIONE
VERSION

CODICE
CODE

DIMENSIONE
SIZE

VERSIONE VERSION	CODICE CODE	DIMENSIONE SIZE	
	F2805	350 x 200 mm	
	F2810	350 x 200 mm	
	F2815	350 x 200 mm	
	F2820	350 x 200 mm	
	F2825	350 x 200 mm	



CLOUD

MENEGHELLO PAOLELLI DESIGN





Soffione Cloud
Cloud showerhead



FINITURA
FINISHING



BS

VERSIONE VERSION	CODICE CODE	DIMENSIONE SIZE
	F2650	400 x 155 mm
	F2653	400 x 227 mm
	F2652	400 x 377 mm
	F2651	400 x 600/900 mm



CLOUD





MENEGHELLO PAOLELLI DESIGN

Soffione Cloud
Cloud showerhead



FINITURA
FINISHING



VERSIONE VERSION	CODICE CODE	DIMENSIONE SIZE
	F2650C	400 x 155 mm
	F2650B	400 x 155 mm
	F2650N	400 x 155 mm
	F2653C	400 x 227 mm
	F2653B	400 x 227 mm
	F2653N	400 x 227 mm
	F2652C	400 x 377 mm
	F2652B	400 x 377 mm
	F2652N	400 x 377 mm
	F2651C	400 x 600/900 mm
	F2651B	400 x 600/900 mm
	F2651N	400 x 600/900 mm



HARMONIA

CENTRO RICERCA FIMA DESIGN

Soffione Harmonia
Harmonia showerhead



FINITURA
FINISHING



CR

VERSIONE
VERSION

CODICE
CODE

DIMENSIONE
SIZE



F2900

950 x 950 mm



F2901

500 x 500 mm



F2902

500 x 500 mm



F2903

700 x 400 mm



F2904

700 x 400 mm



HARMONIA

CENTRO RICERCA FIMA DESIGN

Soffione Harmonia
Harmonia showerhead



FINITURA
FINISHING



VERSIONE
VERSION

CODICE
CODE

DIMENSIONE
SIZE



F5911

Ø 400 mm



SOFFIONI SHOWERHEADS







Soffioni a parete in acciaio inox
Wall mounted stainless steel showerhead



FINITURA
FINISHING



CR

FORMA SHAPE	CODICE CODE	DIMENSIONE SIZE
	F2627	553 x 170 mm
	F2628	553 x 170 mm
	F2346	553 x 170 mm
	F2347	553 x 170 mm
	F2782	300 x 145 mm
	F2623	250 x 90 mm



SOFFIONI SHOWERHEADS

Soffioni a soffitto in acciaio inox
Ceiling mounted stainless steel showerheads



FINITURA
FINISHING





CR

SN

BS

NS

FORMA SHAPE	CODICE CODE	DIMENSIONE SIZE
	F2417	420 x 420 mm
	F2425	500 x 500 mm
	F2426	Ø 500 mm



BRACCI A PARETE E A SOFFITTO

WALL AND CEILING BRACKETS

FINITURA
FINISHING



CODICE CODE	DIMENSIONE SIZE	
F2584	150 mm - 1/2"	○
F2586	300 mm - 1/2"	○
F2585	150 mm - 1/2"	□
F2587	300 mm - 1/2"	□



F2138.30	300 mm - 1/2"	○
F2138	350 mm - 1/2"	○
F2138.45	450 mm - 1/2"	○
F2538	350 mm - 1/2"	□



SQUARE&ROUD SQUARE&ROUND

Soffioni in ottone
Brass showerhead



FINITURA
FINISHING

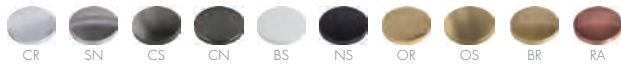

FORMA SHAPE	CODICE CODE	DIMENSIONE SIZE
	F2620/2*	200 x 200 mm
	F2630/2	250 x 250 mm
	F2216/2	300 x 300 mm
	F2639/2	400 x 400 mm
	F2117/2*	Ø 200 mm
	F2621/2	Ø 250 mm
	F2224/2	Ø 300 mm



*DISPONIBILE SOLO IN FINITURA CROMO (CR)
*AVAILABLE ONLY IN CHROME (CR) FINISHING



SQUARE&ROUD SQUARE&ROUND







Soffioni in ABS
ABS showerhead



FINITURA
FINISHING



CR

FORMA SHAPE	CODICE CODE	DIMENSIONE SIZE
	F2445/2	200 x 200 mm
	F2987/2	250 x 250 mm
	F2396/2	220 x 220 mm
	F2795/2	360 x 240 mm
	F2267/2	Ø 200 mm
	F2794/2	Ø 250 mm

ACCIAIO INOX STAINLESS STEEL



FINITURA
FINISHING



INOX

FORMA SHAPE	CODICE CODE	DIMENSIONE SIZE
	F2949/2	200 x 200 mm
	F2950/2	300 x 300 mm
	F2947/2	Ø 200 mm
	F2948/2	Ø 300 mm

DOCLETTE HANDSHOWERS

FINITURA
FINISHING

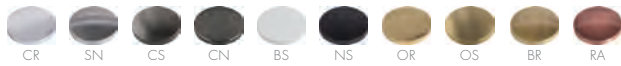

CODICE CODE	DIMENSIONE SIZE	
F2203	27,5 x 212 mm	
F2067	Ø 25 x 187 mm	

F2203



F2067



FINITURA
FINISHING



CODICE CODE	DIMENSIONE SIZE	
F2298	96,5 x 225 mm	

F2298



FINITURA
FINISHING



CODICE CODE	DIMENSIONE SIZE	
F2406	28,5 x 185,5 mm	
F2736	121 x 240 mm	
F2598	97 x 226 mm	
F2589	50 x 222 mm	
F2446	110 x 238 mm	
F2646	139 x 264 mm	
F2491	80 x 250 mm	

F2406



F2736



F2598



F2589



F2446



F2646



F2491



Doccette in ottone Brass handshower

FINITURA
FINISHING



CODICE CODE	DIMENSIONE SIZE	
F2067OT	27,5 x 212 mm	
F2203OT	Ø 25 x 187 mm	

F2067OT



F2203OT



SET DOCCIA SHOWER SET

FINITURA
FINISHING



CODICE
CODE

F2287/4

F2438/2

F2287/4



F2438/2



FINITURA
FINISHING



CODICE
CODE

F2287/2

F2287/5

F2287/9

F2336

F2287/2



F2287/5



F2287/9



F2336



Set doccia in ottone Brass shower set

FINITURA
FINISHING



CODICE
CODE

F2287/4OT

F2438/2OT

F2287/4OT



F2438/2OT

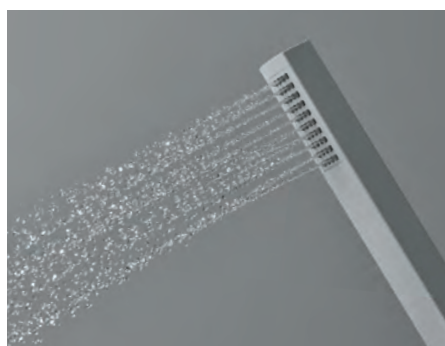

SALISCENDI SLIDING RAIL

Saliscendi in ottone
Brass sliding rail

FINITURA
FINISHING

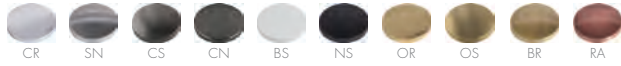

CODICE CODE	ALTEZZA HEIGHT
F2009	876 mm
F2218	855 mm
F2150	855 mm
F2150/1	855 mm

con presa acqua
with water connection

F2009



F2218



F2150



F2150/1



FINITURA
FINISHING



CODICE CODE	ALTEZZA HEIGHT
F2039	876 mm

con presa acqua
with water connection

F2039



FINITURA
FINISHING



CODICE CODE	ALTEZZA HEIGHT
F2679	720 mm
F2679/1	720 mm

F2679



F2679/1



FINITURA
FINISHING



CODICE CODE	ALTEZZA HEIGHT
F2443	900 mm
F2420	855 mm
F2391	820 mm
F2444	800 mm
F2297	696 mm

F2443



F2420



F2391



F2444



F2297



GETTI LATERALI BODY SPRAY

FINITURA
FINISHING



CODICE CODE	DIMENSIONE SIZE
F2416	124,5 x 124,5 mm
F2427	124,5 x 124,5 mm

F2416



F2427

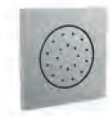

Getti laterali in ottone Brass body spray

FINITURA
FINISHING



CODICE CODE	DIMENSIONE SIZE
F2940	Ø 50 mm
F2339	100 x 100 mm

F2940



F2339



BOCCHE A PARETE PER VASCA WALL MOUNTED BATH SPOUT

FINITURA
FINISHING



CODICE CODE	BOCCA SPOUT
F2929	207 mm
F2424	201 mm

F2929



F2424



FINITURA
FINISHING



CODICE CODE	BOCCA SPOUT
F2398	197 mm
F2418	201 mm

F2398



F2418



FINITURA
FINISHING



CODICE CODE	BOCCA SPOUT
F2334	175 mm
F2781	220 mm
F2456	201 mm
F2040	132 mm
F2041	132 mm

F2334



F2781

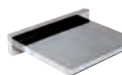

F2456



F2040



F2041



BOCCHE BORDO VASCA DECK MOUNTED BATH SPOUT

FINITURA
FINISHING



CODICE CODE	BOCCA SPOUT
F2415	165 mm
F2158	230 mm

F2415



F2158



FINITURA
FINISHING



CODICE CODE	BOCCA SPOUT
F2643	157 mm

F2643



FINITURA
FINISHING



CODICE CODE	BOCCA SPOUT
F2367	157 mm
F2457	188 mm

F2367



F2457



INOX STAINLESS STEEL

FINITURA
FINISHING



INOX

CODICE CODE	DIMENSIONE SIZE
F2950/2INOX	300 x 300 mm
F2949/2INOX	200 x 200 mm
F2948/2INOX	Ø 300 mm
F2947/2INOX	Ø 200 mm

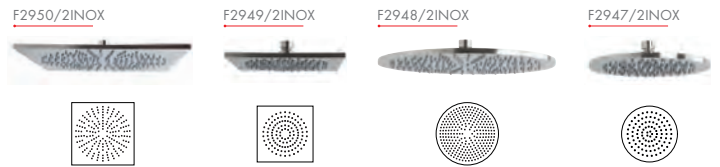

F2946INOX	250 mm - 1/2"
F2945INOX	350 mm - 1/2"



F2956INOX	Ø 23 x 187 mm
-----------	---------------



F2951INOX	Ø 23 x 236,5 mm
-----------	-----------------



F2953INOX	89 x 905 mm
-----------	-------------



F2944INOX	202 mm
-----------	--------

F2943INOX	230 mm
-----------	--------





Handwritten text in a cursive script, likely Urdu or Persian, covering the majority of the page. The text is organized into approximately 15 vertical columns, with each column starting from a small black marker at the top. The script is dense and fills most of the page area.

graphic project
FIMA CARLO FRATTINI
photo
WALTER ZERLA

fima | CARLO FRATTINI®
PUBBLICITÀ

© Fima Carlo Frattini S.p.A.
tutti i diritti riservati / All rights reserved

printed in Italy 06-2021

F8034/21 WELLNESS

