

Code F5081/5

### 3-LOCH WANDWASCHTISCHBATTERIE

- Nur Farbset
- Messing Push-open Ablaufgarnitur 1"1/4
- **UP Körper separat zu bestellen**

### BILD



### Finishes

-  CHROM  
CR
-  NICKEL GEBÜRSTET  
SN
-  GOLD  
OR
-  GOLD GEBÜRSTET  
OS
-  BRONZE  
BR
-  ALTE KUPFER  
RA

**PRODUKTE MUSSTEN SEPARAT  
BESTELLT WERDEN**

[UP Körper](#)



Siehe die allgemeinen Verkaufsbedingungen auf unserer  
geltenden Preisliste

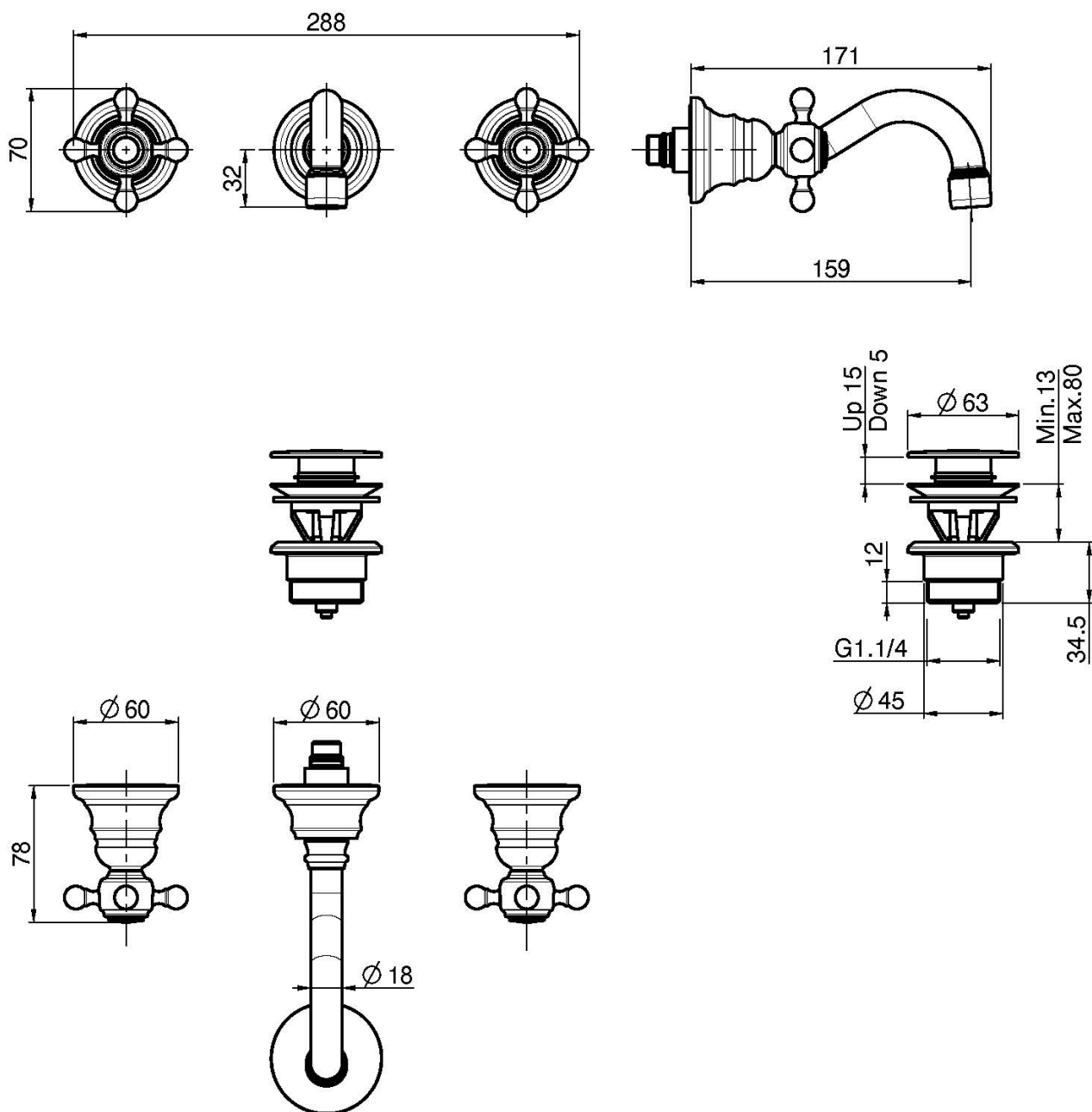

This drawing is the property of FIMA Carlo Frattini. Any complete or partial reproduction, or any transmission to third party without FIMA Carlo Frattini authorization is forbidden.

