

Code F5081L/5

3-LOCH WANDWASCHTISCHBATTERIE

- Nur Farbset
- Messing Push-open Ablaufgarnitur 1"1/4
- **UP Körper separat zu bestellen**

BILD



Finishes

-  CHROM
CR
-  NICKEL GEBÜRSTET
SN
-  GOLD
OR
-  GOLD GEBÜRSTET
OS
-  BRONZE
BR
-  ALTE KUPFER
RA

**PRODUKTE MUSSTEN SEPARAT
BESTELLT WERDEN**

[UP Körper](#)



Siehe die allgemeinen Verkaufsbedingungen auf unserer
geltenden Preisliste

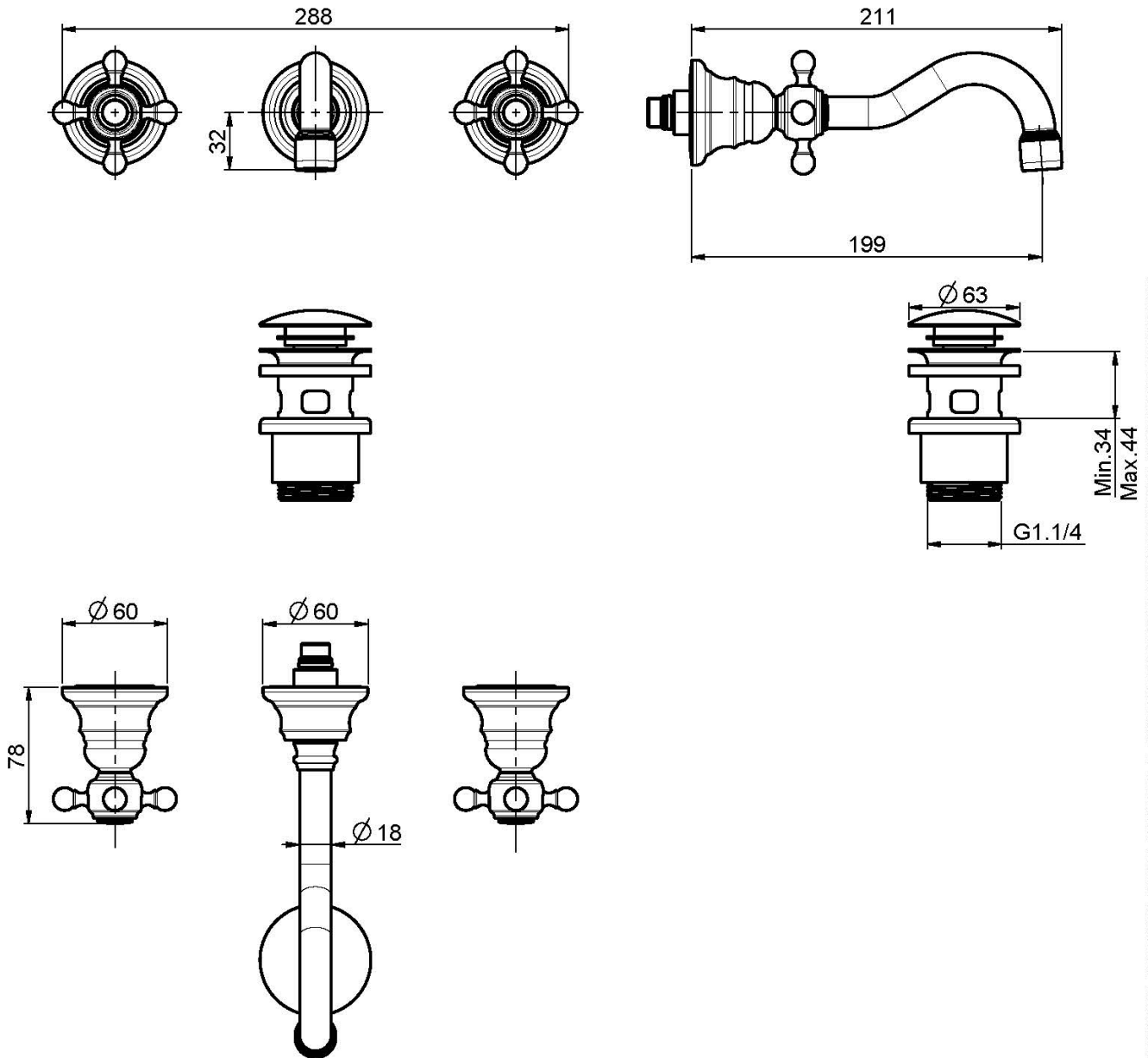

This drawing is the property of FIMA Carlo Frattini. Any complete or partial reproduction, or any transmission to third party without FIMA Carlo Frattini authorization is forbidden.

