

Code F3305

AP BRAUSEBATTERIE MIT BRAUSESET

- Nr. 2 Exzenteranschlüsse 1/2"
- Messing Schlauch 1500 mm
- Handbrause mit Antikalkdüsen
- Brausehalterung

Finishes

-  CHROM
CR
-  NICKEL GEBÜRSTET
SN
-  GOLD
OR
-  GOLD GEBÜRSTET
OS
-  BRONZE
BR
-  ALTE KUPFER
RA

BILD



Siehe die allgemeinen Verkaufsbedingungen auf unserer
geltenden Preisliste

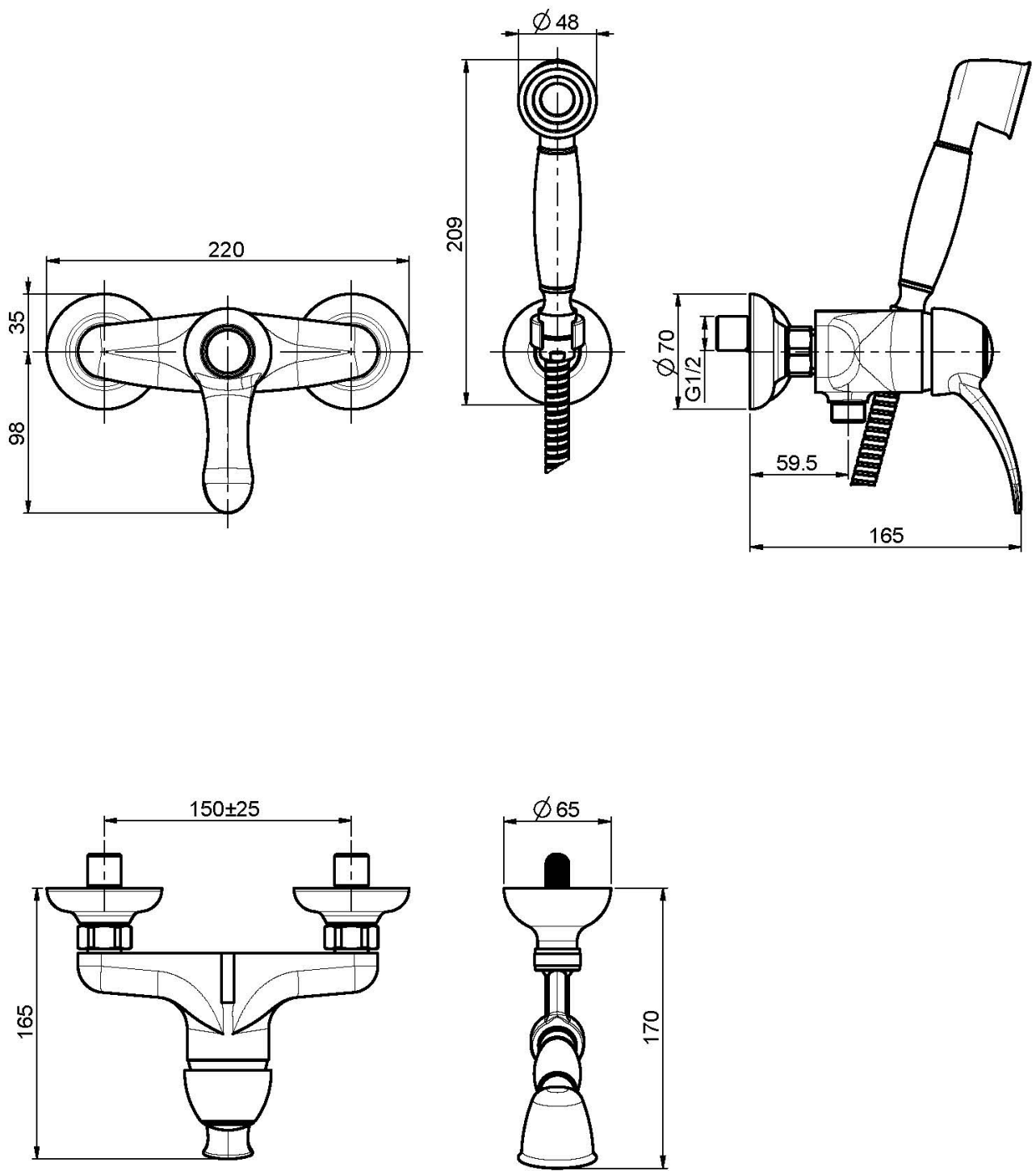

This drawing is the property of FIMA Carlo Frattini. Any complete or partial reproduction, or any transmission to third party without FIMA Carlo Frattini authorization is forbidden.