

Code F5054

## AP WANNENBATTERIE MIT BRAUSESET

- Nr. 2 Exzenteranschlüsse 1/2"
- Messing Schlauch 1500 mm
- Handbrause mit Antikalkdüsen
- Umsteller

## Finishes

-  CHROM  
CR
-  NICKEL GEBÜRSTET  
SN
-  GOLD  
OR
-  GOLD GEBÜRSTET  
OS
-  BRONZE  
BR
-  ALTE KUPFER  
RA

## BILD



Siehe die allgemeinen Verkaufsbedingungen auf unserer geltenden Preisliste

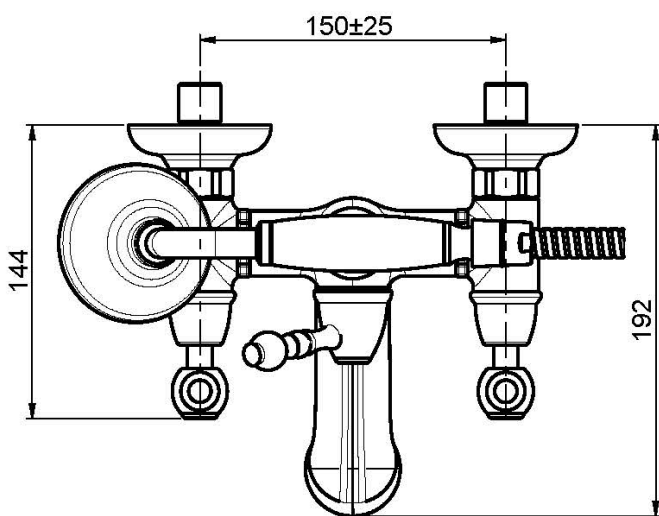
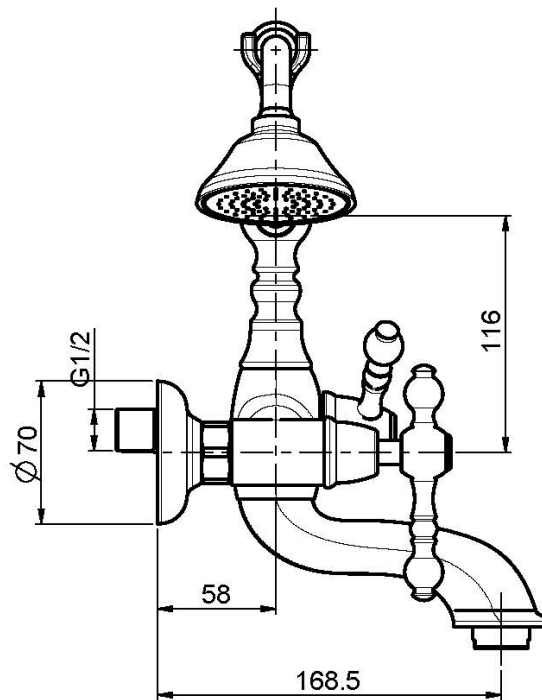
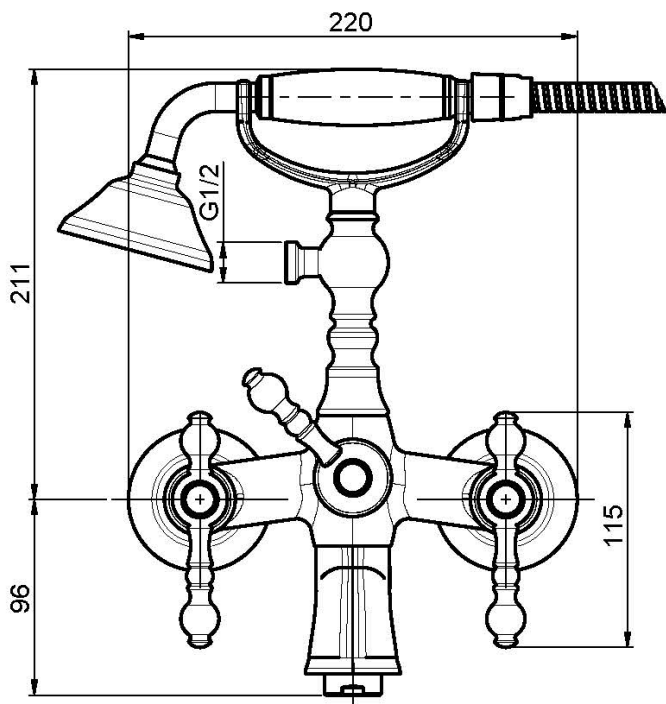

This drawing is the property of FIMA Carlo Frattini. Any complete or partial reproduction, or any transmission to third party without FIMA Carlo Frattini authorization is forbidden.