

Код F3207/1

SPÜLTISCHBATTERIE

- n. 2 Flexschläuche
- drehbarer Auslauf

Finishes

 XPOM
CR

ИЗОБРАЖЕНИЕ



Общие условия продажи в нашем действующем прайс-листе.

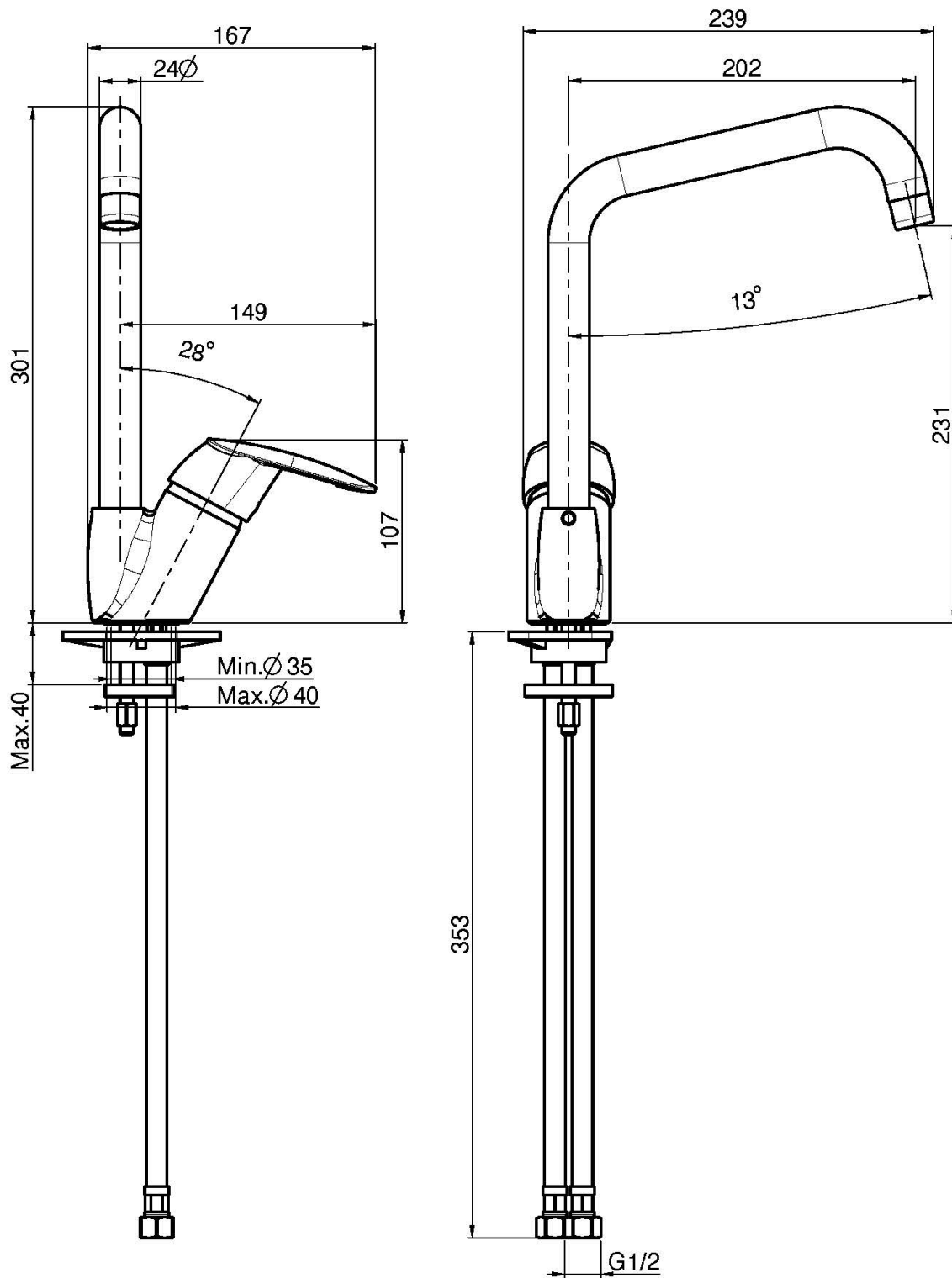

This drawing is the property of FIMA Carlo Frattini. Any complete or partial reproduction, or any transmission to third party without FIMA Carlo Frattini authorization is forbidden.