

Code F2039







BRASS SLIDING RAIL WITH WATER CONNECTION

- 3 jets ABS handshower with antilimestone nozzles
- chromalux flexible hose 1500 mm
- water connection 1/2" included

IMAGE



Finishes

-  CHROM
CR
-  BRUSHED NICKEL
SN
-  BLACK CHROME
CN
-  BRUSHED BLACK CHROME
CS
-  WHITE MATT
BS
-  BLACK MATT
NS
-  GOLD
OR



See the general sales conditions in our current pricelist

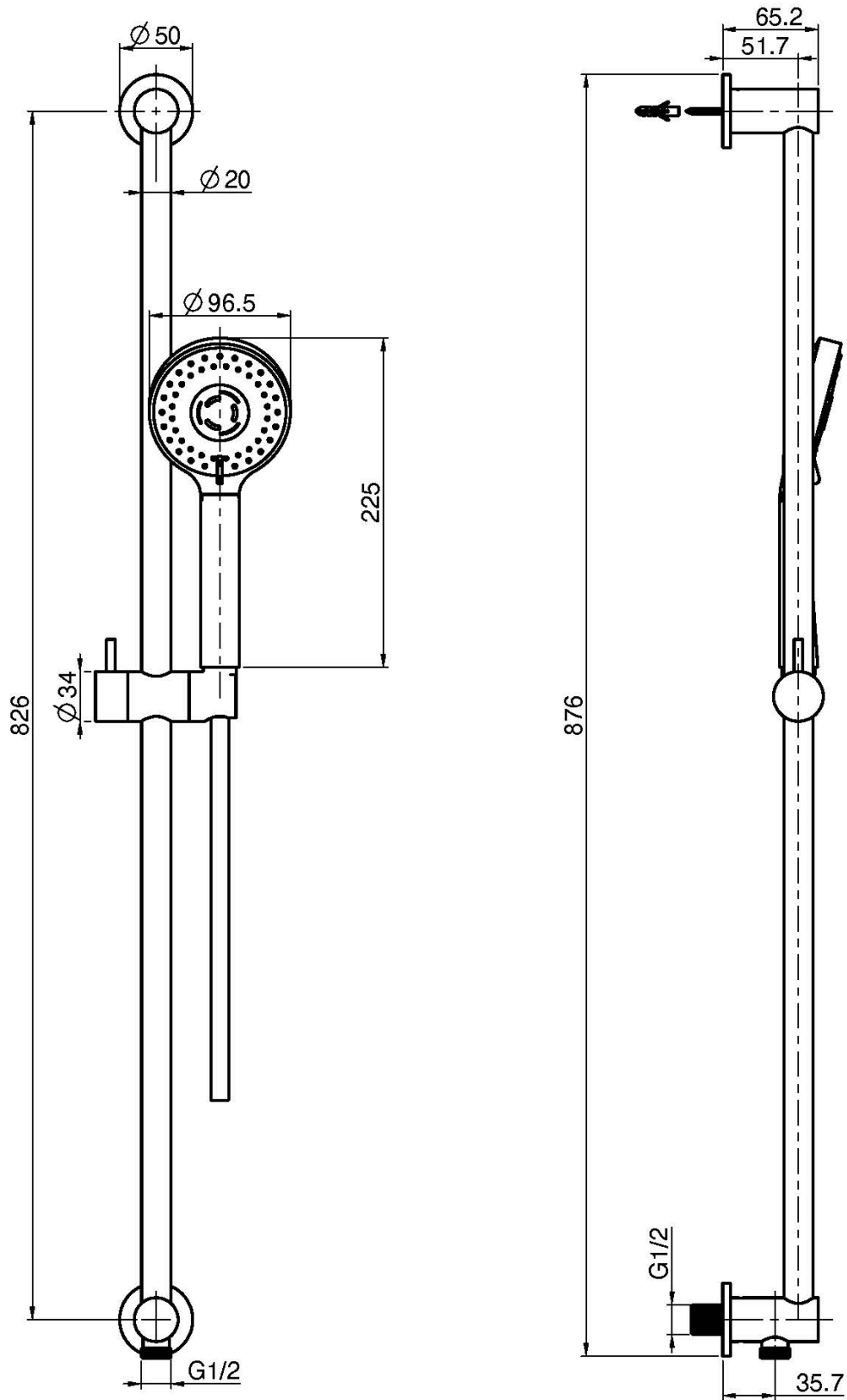

This drawing is the property of FIMA Carlo Frattini. Any complete or partial reproduction, or any transmission to third party without FIMA Carlo Frattini authorization is forbidden.