

Code F5614/1



DECK MOUNTED BATH TAP

- **COVER TO BE ORDERED SEPARATELY**
- 1500 mm nylon flexible hose
- shower holder
- handshower with antilimestone nozzles
- diverter











IMAGE



Texture

-  H COLLECTION
-  V COLLECTION
-  X COLLECTION

Finishing

-  CHROM
CR
-  HL
-  HS
-  ZL
-  ZS
-  BRUSHED NICKEL
SN
-  BLACK CHROME
CN
-  BRUSHED BLACK CHROME
CS
-  WHITE MATT
BS
-  BLACK MATT
NS
-  GOLD
OR
-  BRUSHED GOLD
OS

PRODUCTS NEEDED TO BE ORDERED SEPARATELY

[C3](#)

[Inox cover plate](#)



See the general sales conditions in our current pricelist

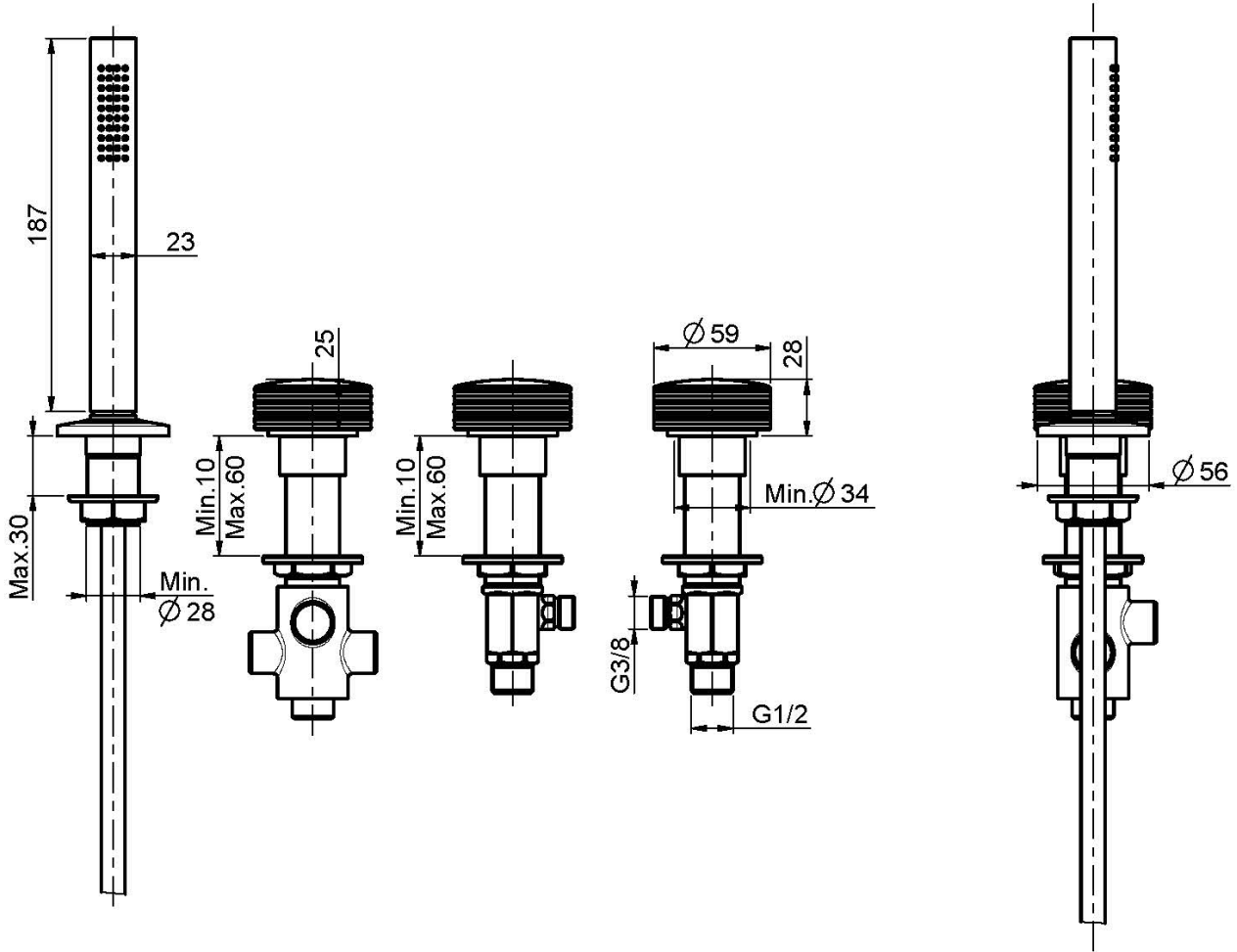

This drawing is the property of FIMA Carlo Frattini. Any complete or partial reproduction, or any transmission to third party without FIMA Carlo Frattini authorization is forbidden.

