

Code F5614/1



## DECK MOUNTED BATH TAP

- **COVER TO BE ORDERED SEPARATELY**
- 1500 mm nylon flexible hose
- shower holder
- handshower with antilimestone nozzles
- diverter











## IMAGE



## Texture

-  H COLLECTION
-  V COLLECTION
-  X COLLECTION

## Finishing

-  CHROM  
CR
-  HL
-  HS
-  ZL
-  ZS
-  BRUSHED NICKEL  
SN
-  BLACK CHROME  
CN
-  BRUSHED BLACK CHROME  
CS
-  WHITE MATT  
BS
-  BLACK MATT  
NS
-  GOLD  
OR
-  BRUSHED GOLD  
OS

## PRODUCTS NEEDED TO BE ORDERED SEPARATELY

[C3](#)

[Inox cover plate](#)



See the general sales conditions in our current pricelist

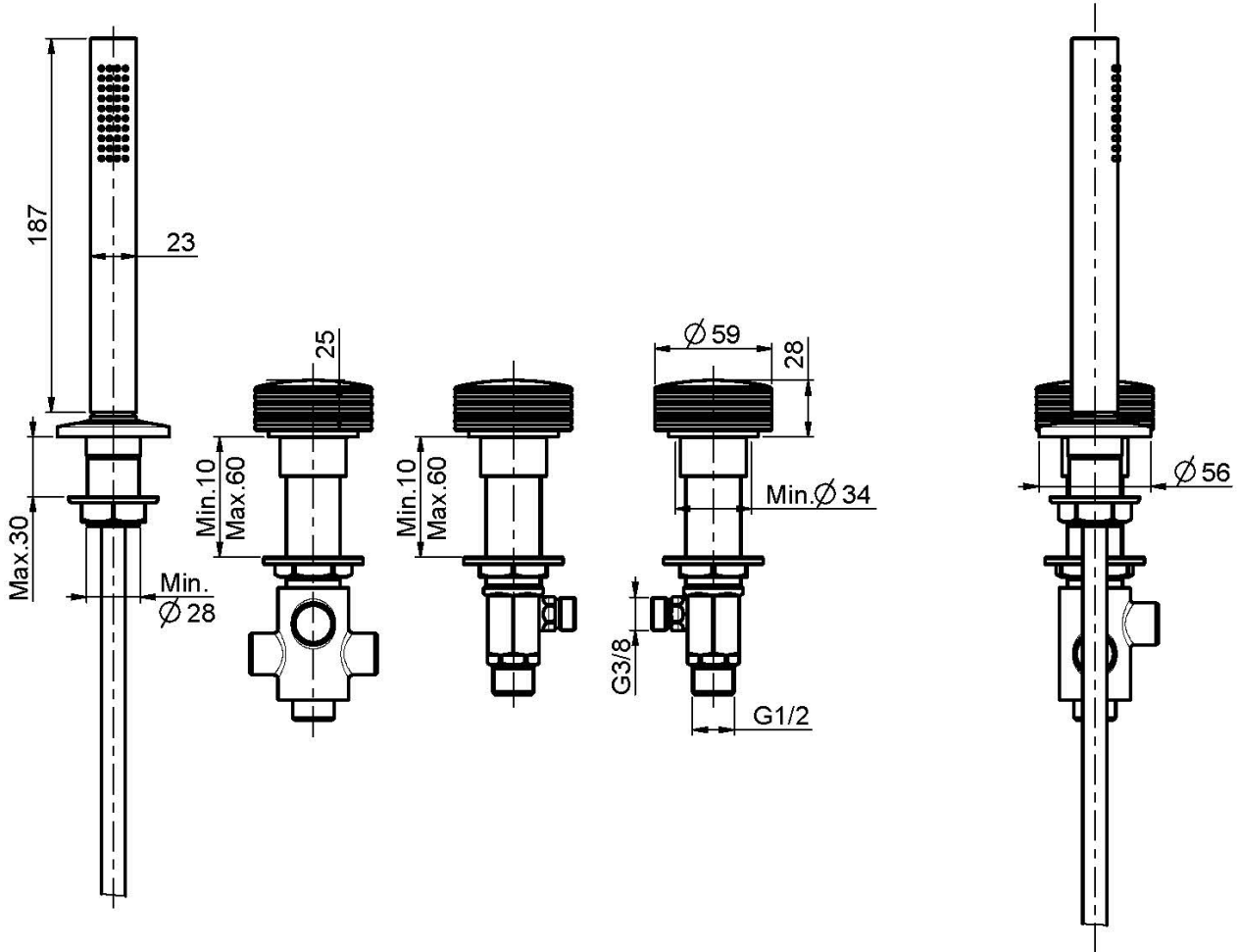

This drawing is the property of FIMA Carlo Frattini. Any complete or partial reproduction, or any transmission to third party without FIMA Carlo Frattini authorization is forbidden.

