

Code F5314







DECK MOUNTED BATH TAP

- 1500 mm nylon flexible hose
- shower holder
- handshower with antilimestone nozzles
- diverter

IMAGE



Finishing

-  CHROM
CR
-  HL
-  HS
-  BRUSHED NICKEL
SN
-  BLACK CHROME
CN
-  BRUSHED BLACK CHROME
CS
-  WHITE MATT
BS
-  BLACK MATT
NS

PRODUCTS NEEDED TO BE ORDERED SEPARATELY

[Inox cover plate](#)



See the general sales conditions in our current pricelist

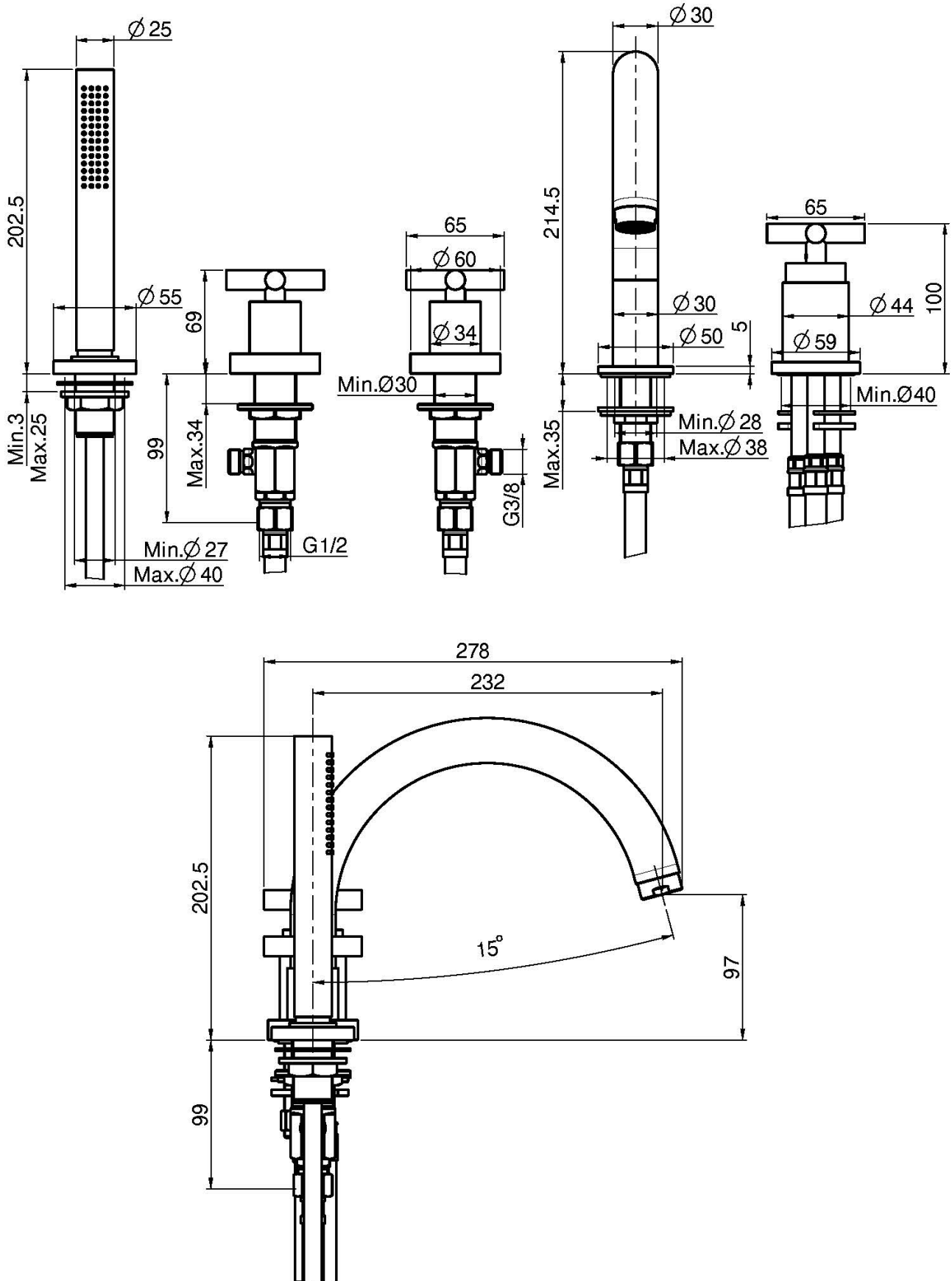

This drawing is the property of FIMA Carlo Frattini. Any complete or partial reproduction, or any transmission to third party without FIMA Carlo Frattini authorization is forbidden.

