

Code F5014

DECK MOUNTED BATH TAP

- 1500 mm nylon flexible hose
- handshower with antilimestone nozzles
- diverter
- shower holder

IMAGE



Finishing

-  CHROM
CR
-  BRUSHED NICKEL
SN
-  GOLD
OR
-  BRUSHED GOLD
OS
-  OLD BRONZE
BR
-  ANTIQUE COPPER
RA

PRODUCTS NEEDED TO BE ORDERED SEPARATELY

[Inox cover plate](#)



See the general sales conditions in our current pricelist

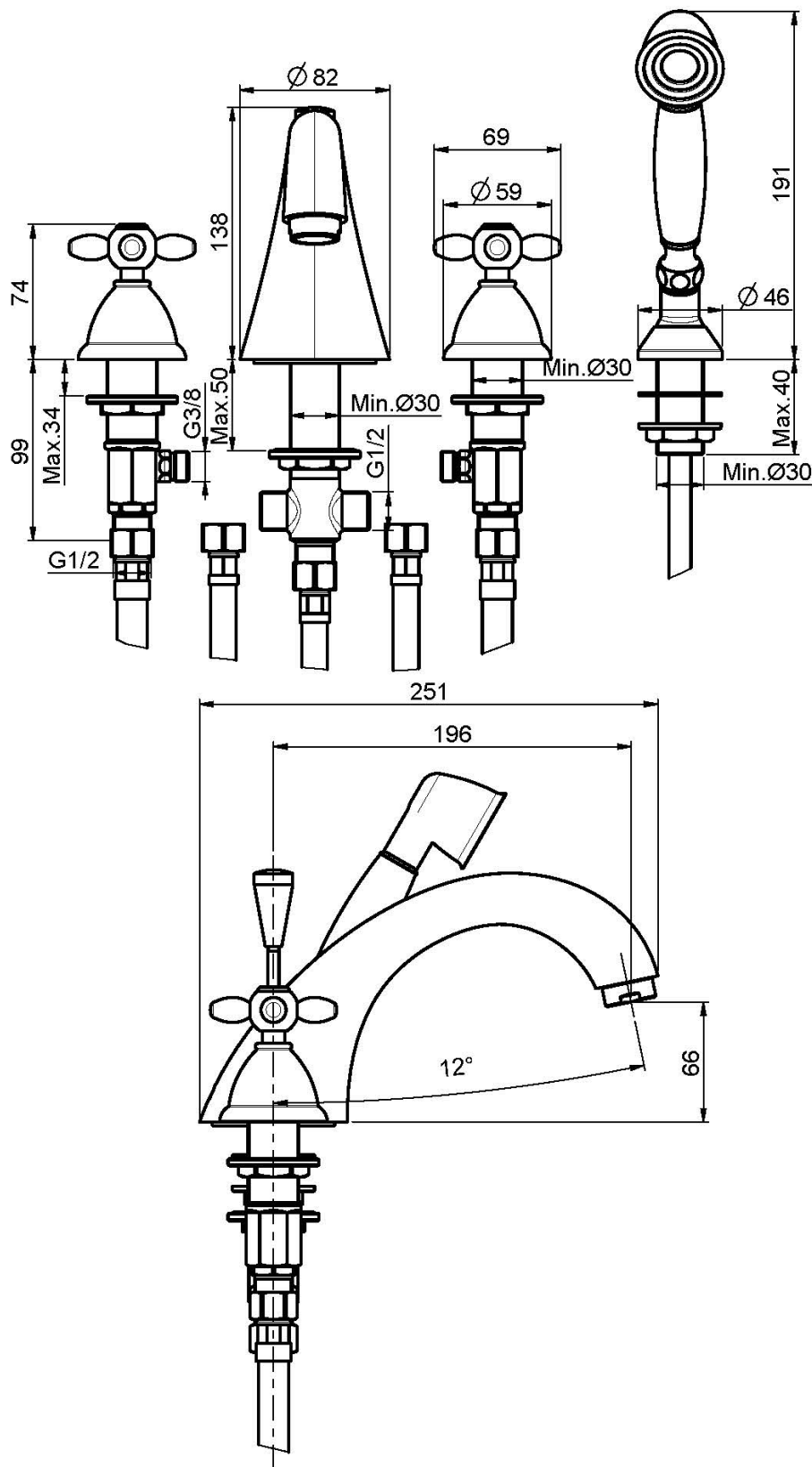

This drawing is the property of FIMA Carlo Frattini. Any complete or partial reproduction, or any transmission to third party without FIMA Carlo Frattini authorization is forbidden.

