









Code F5305/2

EXPOSED SHOWER TAP WITH SHOWER COLUMN, SHOWERHEAD AND SHOWER SET MAXIMA

- adjustable height column
- n. 2 eccentric couplings 1/2"
- handshower with antilimestone nozzles
- brass showerhead Ø 250 mm with antilimestone nozzles
- diverter
- chromalux flexible hose 1500 mm

Finishing

-  CHROM
CR
-  HL
-  HS
-  BRUSHED NICKEL
SN
-  BLACK CHROME
CN
-  BRUSHED BLACK CHROME
CS
-  WHITE MATT
BS
-  BLACK MATT
NS

IMAGE



See the general sales conditions in our current pricelist

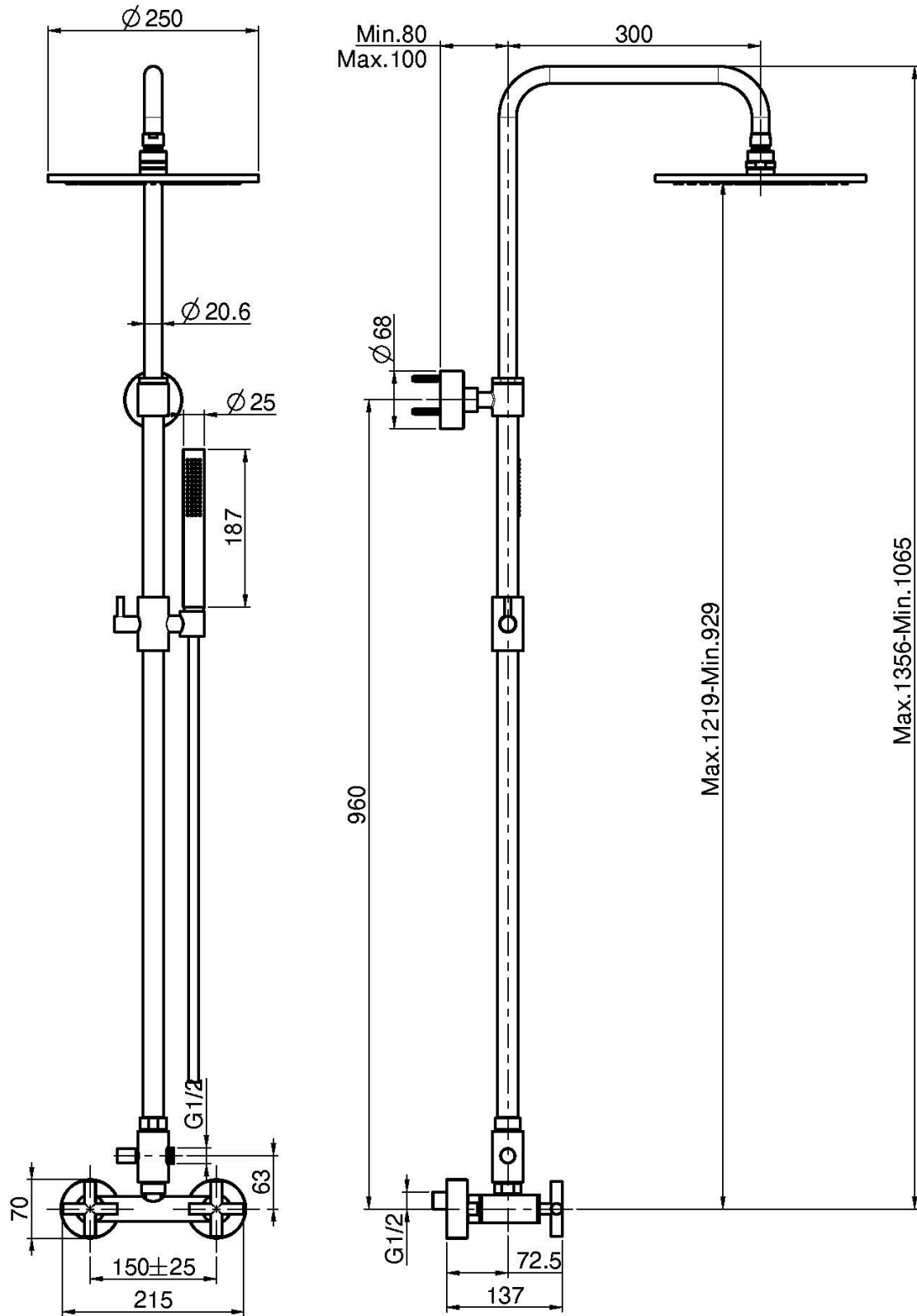

This drawing is the property of FIMA Carlo Frattini. Any complete or partial reproduction, or any transmission to third party without FIMA Carlo Frattini authorization is forbidden.