







Code F5305/2

## EXPOSED SHOWER TAP WITH SHOWER COLUMN, SHOWERHEAD AND SHOWER SET MAXIMA

- adjustable height column
- n. 2 eccentric couplings 1/2"
- handshower with antilimestone nozzles
- brass showerhead Ø 250 mm with antilimestone nozzles
- diverter
- chromalux flexible hose 1500 mm

## Finishing

-  CHROM  
CR
-  HL
-  HS
-  BRUSHED NICKEL  
SN
-  BLACK CHROME  
CN
-  BRUSHED BLACK CHROME  
CS
-  WHITE MATT  
BS
-  BLACK MATT  
NS

## IMAGE



See the general sales conditions in our current pricelist

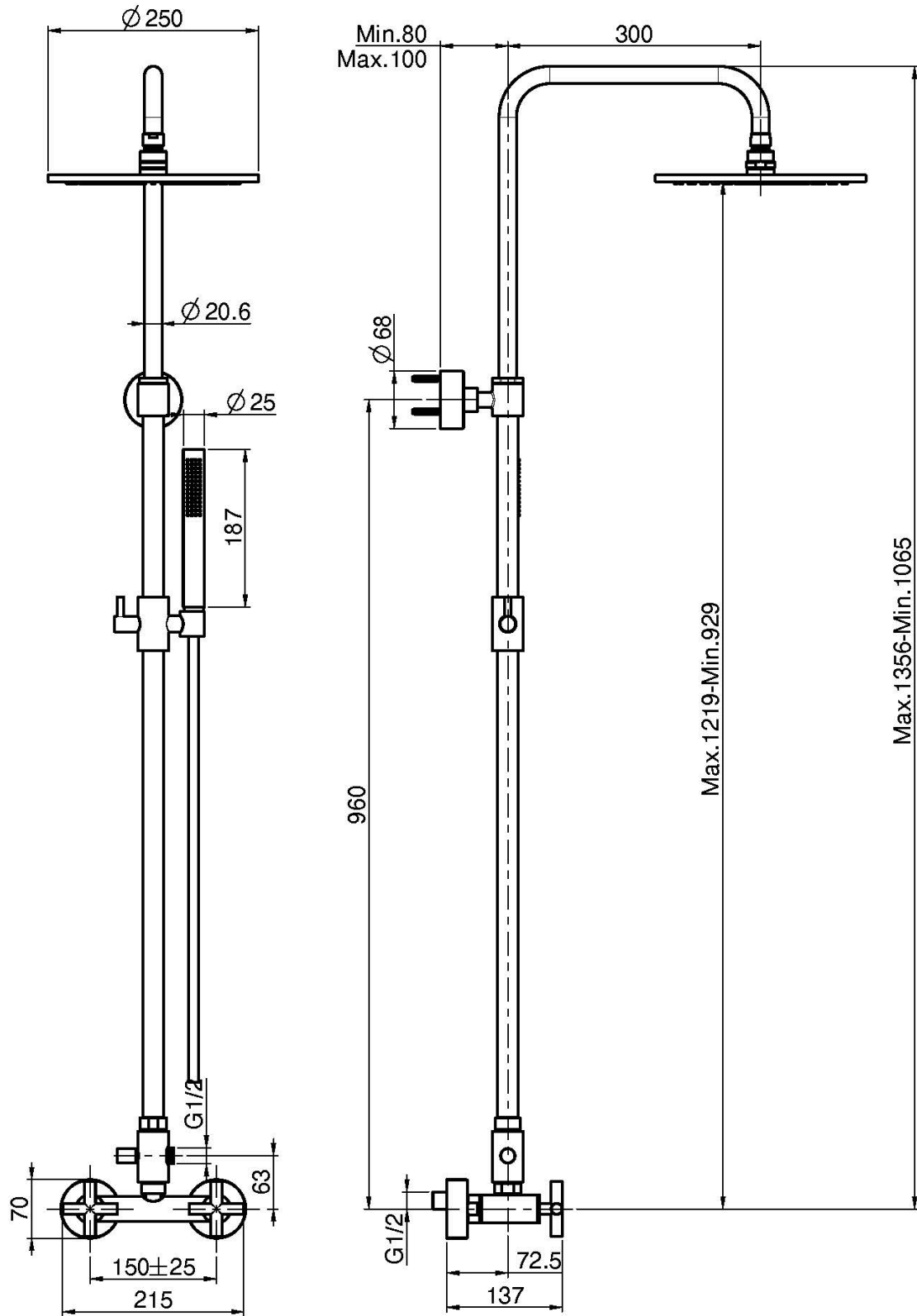

This drawing is the property of FIMA Carlo Frattini. Any complete or partial reproduction, or any transmission to third party without FIMA Carlo Frattini authorization is forbidden.