

Code F5305/1









## EXPOSED SHOWER TAP WITHOUT SHOWER SET

- n. 2 eccentric couplings 1/2"

### IMAGE



### Finishing

-  CHROM  
CR
-  HL
-  HS
-  BRUSHED NICKEL  
SN
-  BLACK CHROME  
CN
-  BRUSHED BLACK CHROME  
CS
-  WHITE MATT  
BS
-  BLACK MATT  
NS



See the general sales conditions in our current pricelist

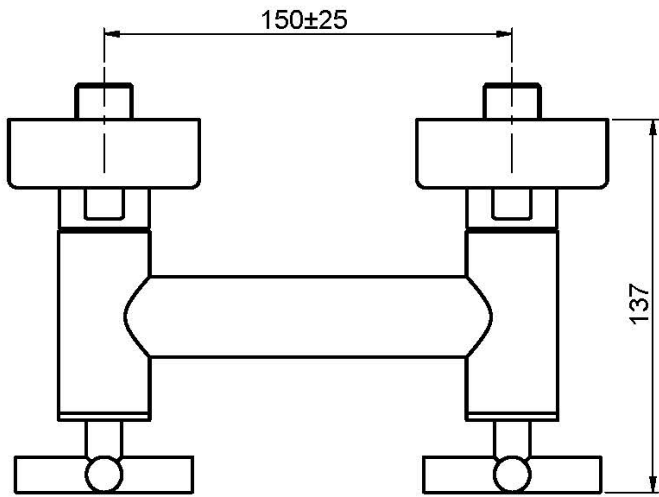
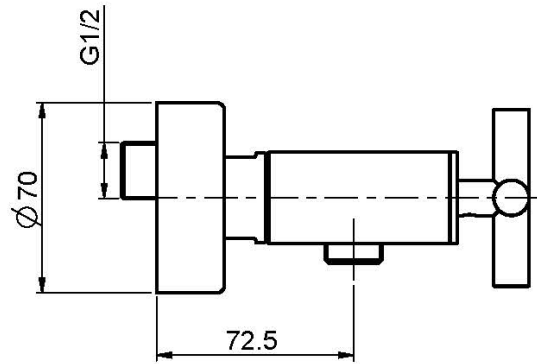
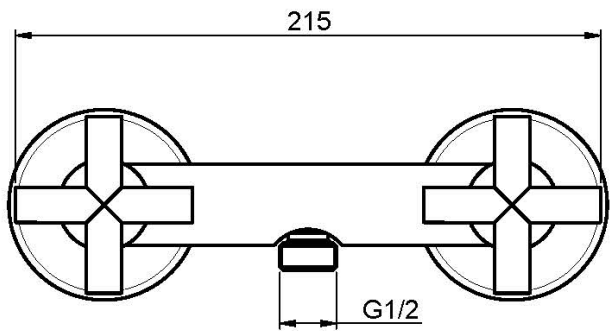

This drawing is the property of FIMA Carlo Frattini. Any complete or partial reproduction, or any transmission to third party without FIMA Carlo Frattini authorization is forbidden.