











Code F4284

EXPOSED THERMOSTATIC BATH MIXER WITH SHOWER SET WITH METAL HANDLES

- n. 2 eccentric couplings 1/2"
- water saving 50%
- handshower with antilimestone nozzles
- shower holder
- diverter
- chromalux flexible hose 1500 mm
- COLD BODY

Finishing

-  CHROM
CR
-  HL
-  HS
-  ZL
-  ZS
-  BRUSHED NICKEL
SN
-  BLACK CHROME
CN
-  BRUSHED BLACK CHROME
CS
-  WHITE MATT
BS
-  BLACK MATT
NS
-  GOLD
OR
-  BRUSHED GOLD
OS

IMAGE



See the general sales conditions in our current pricelist

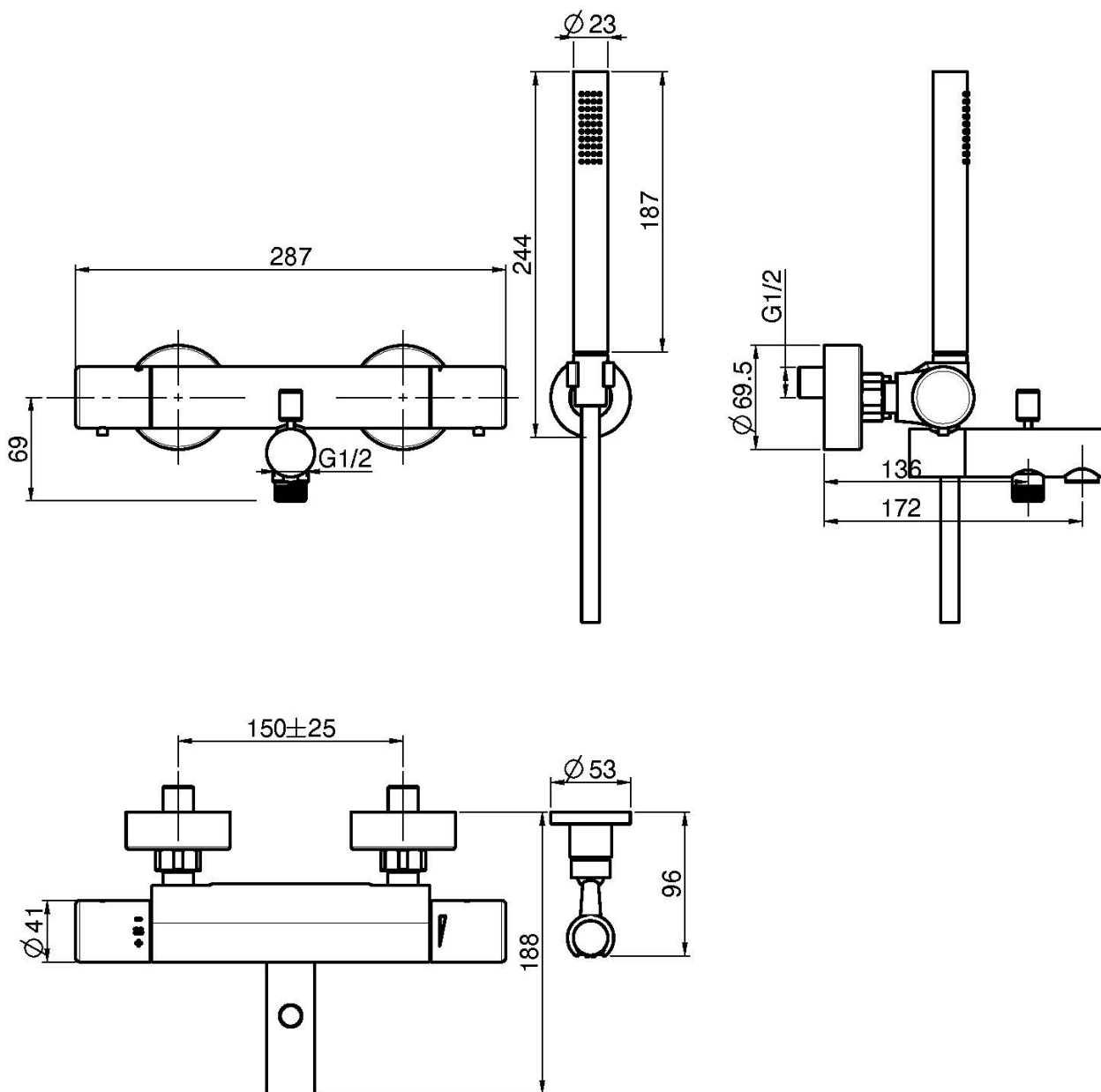

This drawing is the property of FIMA Carlo Frattini. Any complete or partial reproduction, or any transmission to third party without FIMA Carlo Frattini authorization is forbidden.