











Code F7047

KITCHEN MIXER WITH EXTRACTABLE HANDSHOWER FLEXI

- n. 2 flexible hoses
- brass extractable handshower
- swivel spout
- CR and SN finishing use flexible grey, finishing CN-CS-NS-HL-HS-ZL-ZS use flexible black, finishing BS use flexible white

Finishing

-  CHROM
CR
-  HL
-  HS
-  ZL
-  ZS
-  BRUSHED NICKEL
SN
-  BLACK CHROME
CN
-  BRUSHED BLACK CHROME
CS
-  WHITE MATT
BS
-  BLACK MATT
NS
-  GOLD
OR
-  BRUSHED GOLD
OS

IMAGE



See the general sales conditions in our current pricelist

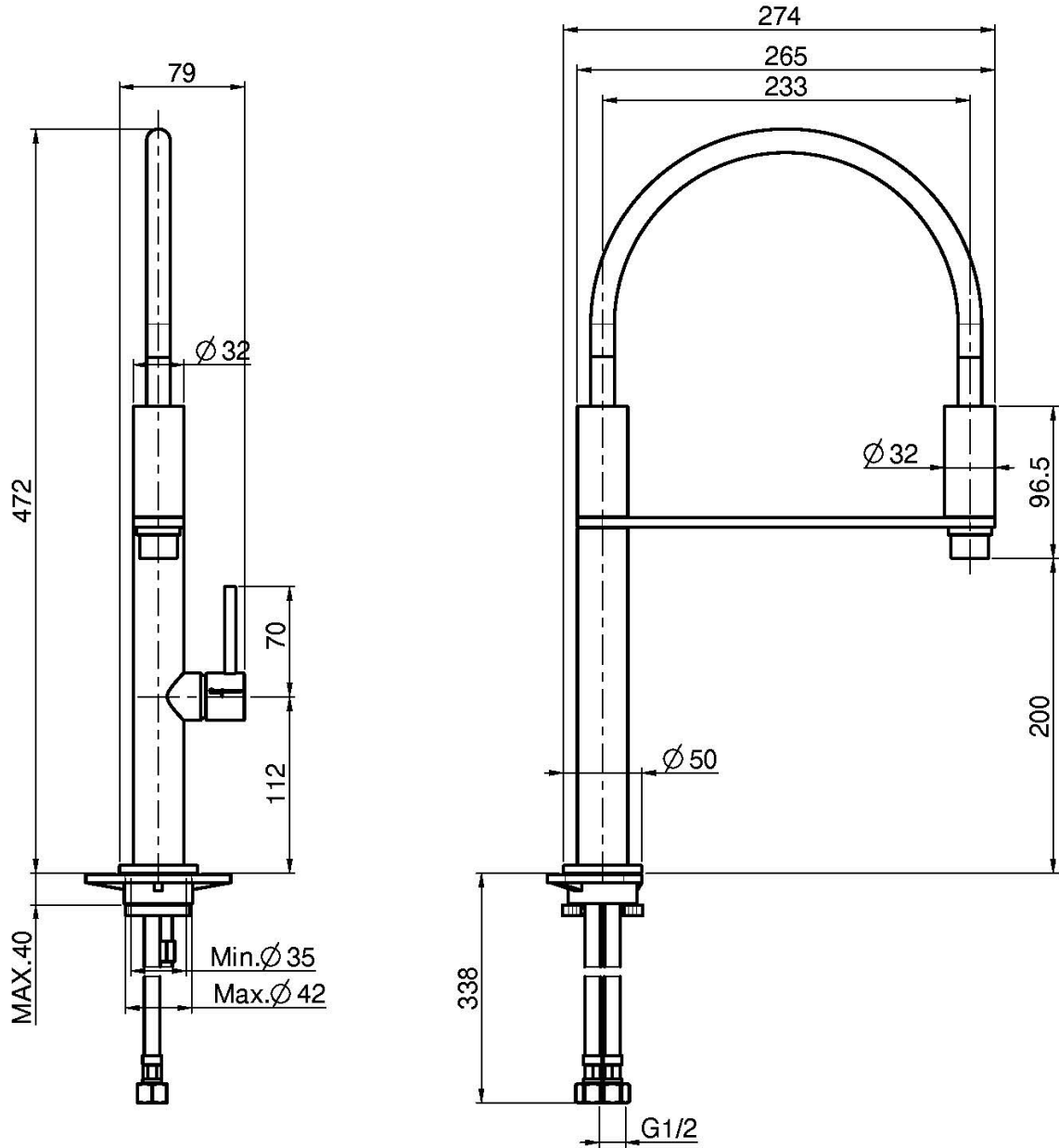

This drawing is the property of FIMA Carlo Frattini. Any complete or partial reproduction, or any transmission to third party without FIMA Carlo Frattini authorization is forbidden.