











Code F7047

## KITCHEN MIXER WITH EXTRACTABLE HANDSHOWER FLEXI

- n. 2 flexible hoses
- brass extractable handshower
- swivel spout
- CR and SN finishing use flexible grey, finishing CN-CS-NS-HL-HS-ZL-ZS use flexible black, finishing BS use flexible white

## Finishing

-  CHROM  
CR
-  HL
-  HS
-  ZL
-  ZS
-  BRUSHED NICKEL  
SN
-  BLACK CHROME  
CN
-  BRUSHED BLACK CHROME  
CS
-  WHITE MATT  
BS
-  BLACK MATT  
NS
-  GOLD  
OR
-  BRUSHED GOLD  
OS

## IMAGE



See the general sales conditions in our current pricelist

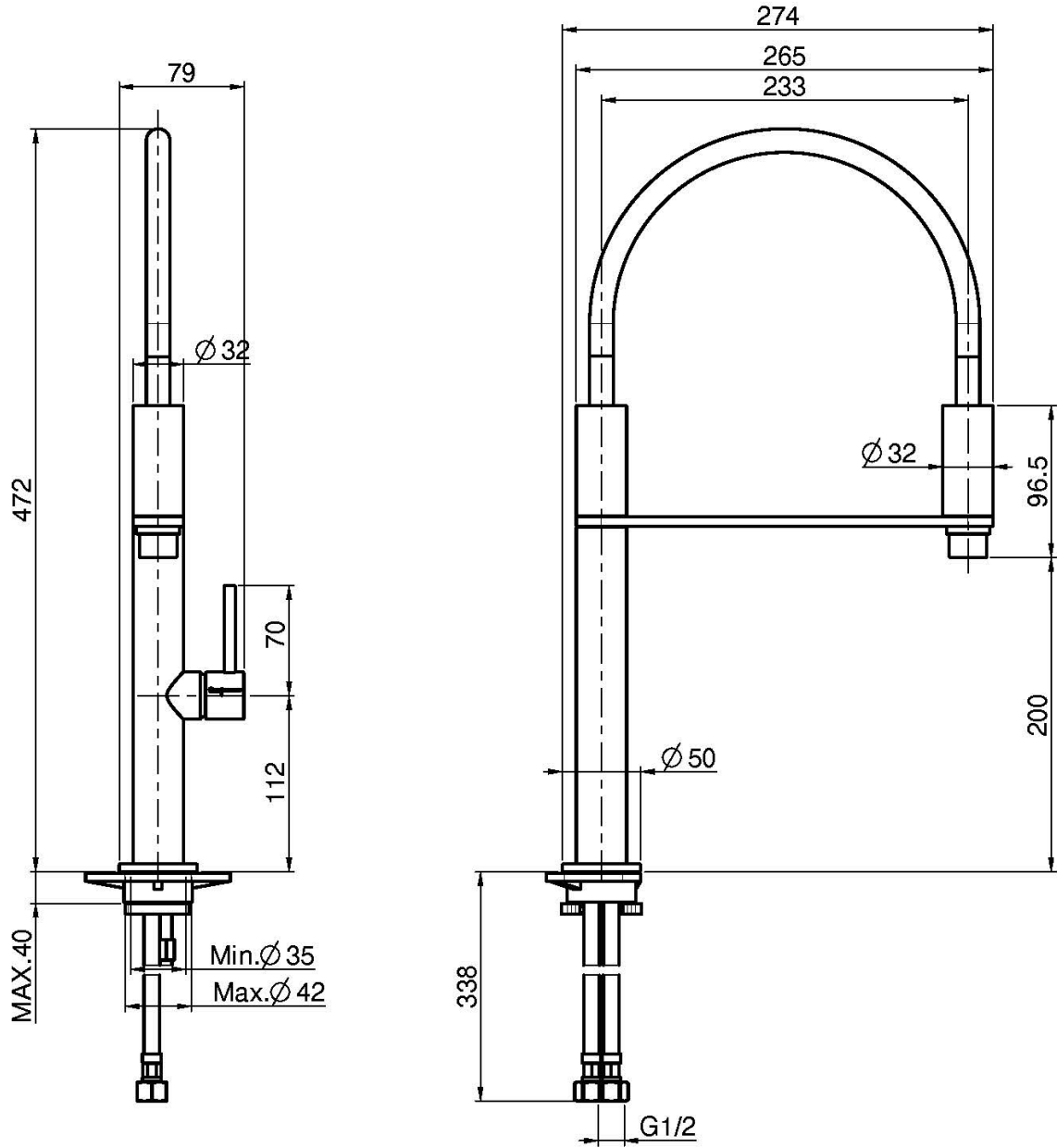

This drawing is the property of FIMA Carlo Frattini. Any complete or partial reproduction, or any transmission to third party without FIMA Carlo Frattini authorization is forbidden.