

Code F5333X4









## THERMOSTATIC BUILT-IN SHOWER MIXER MAXIMA

- 4 volume control valves
- safety stop handle 38°
- exposed part only
- horizontal or vertical installation
- **built-in part to be ordered separately**

### IMAGE



### Finishing

-  CHROM  
CR
-  HL
-  HS
-  BRUSHED NICKEL  
SN
-  BLACK CHROME  
CN
-  BRUSHED BLACK CHROME  
CS
-  WHITE MATT  
BS
-  BLACK MATT  
NS

### PRODUCTS NEEDED TO BE ORDERED SEPARATELY

#### Built-in part



See the general sales conditions in our current pricelist

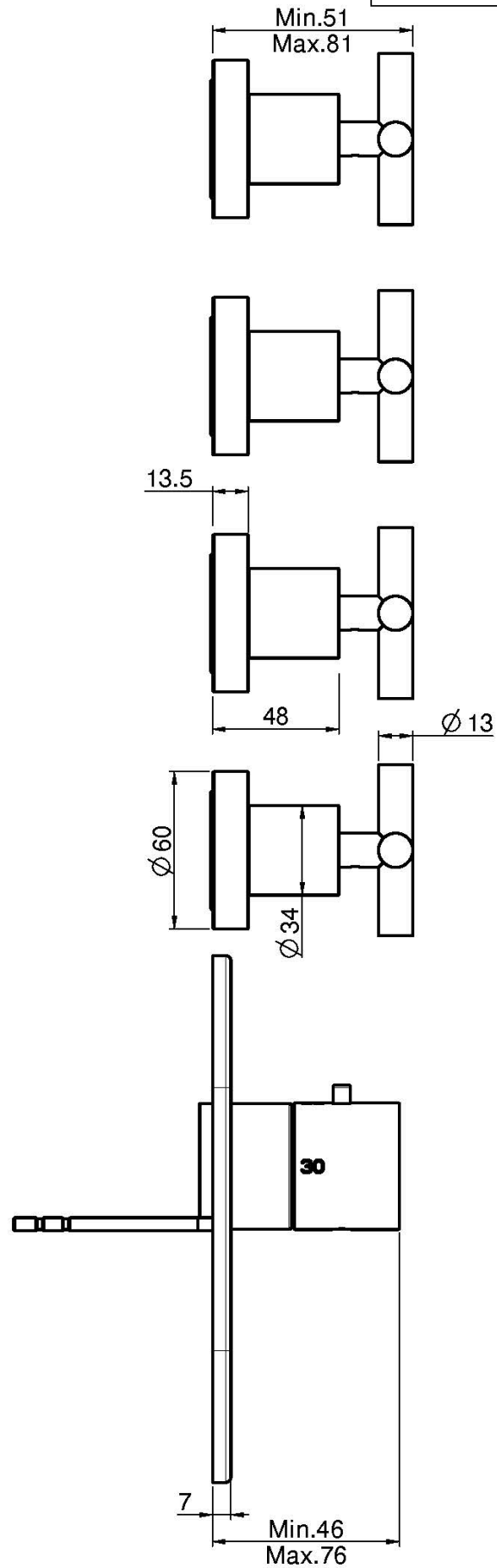
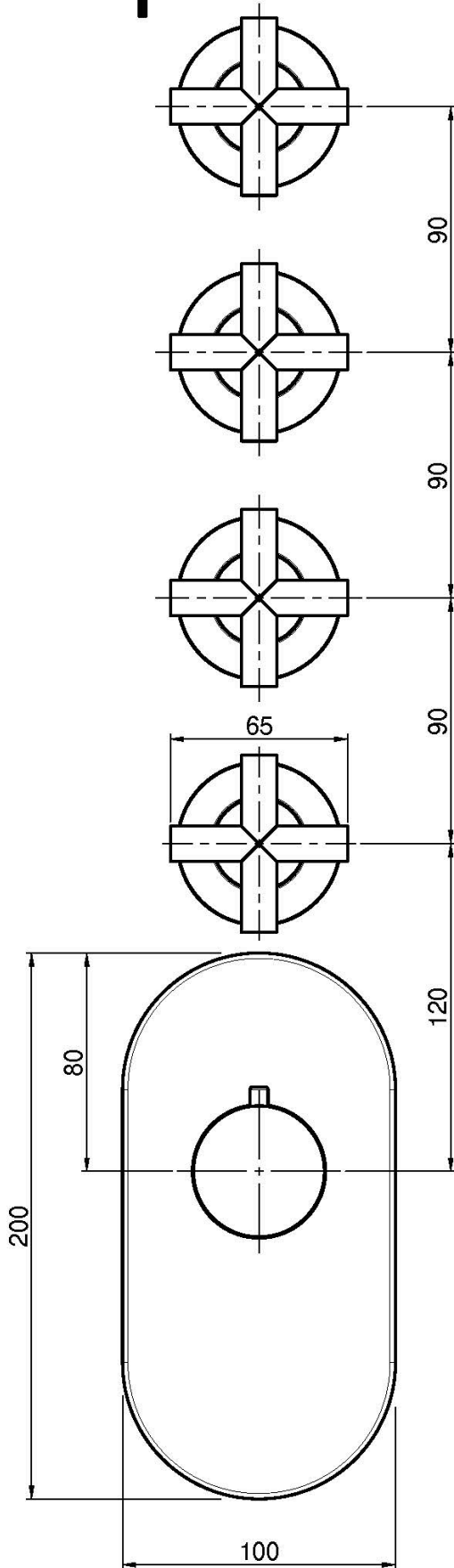

This drawing is the property of FIMA Carlo Frattini. Any complete or partial reproduction, or any transmission to third party without FIMA Carlo Frattini authorization is forbidden.

