

Code F5333X3







THERMOSTATIC BUILT-IN SHOWER MIXER MAXIMA

- safety stop handle 38°
- 3 volume control valves
- exposed part only
- horizontal or vertical installation
- **built-in part to be ordered separately**

IMAGE



Finishing

-  CHROM
CR
-  HL
-  HS
-  BRUSHED NICKEL
SN
-  BLACK CHROME
CN
-  BRUSHED BLACK CHROME
CS
-  WHITE MATT
BS
-  BLACK MATT
NS

PRODUCTS NEEDED TO BE ORDERED SEPARATELY

Built-in part



See the general sales conditions in our current pricelist

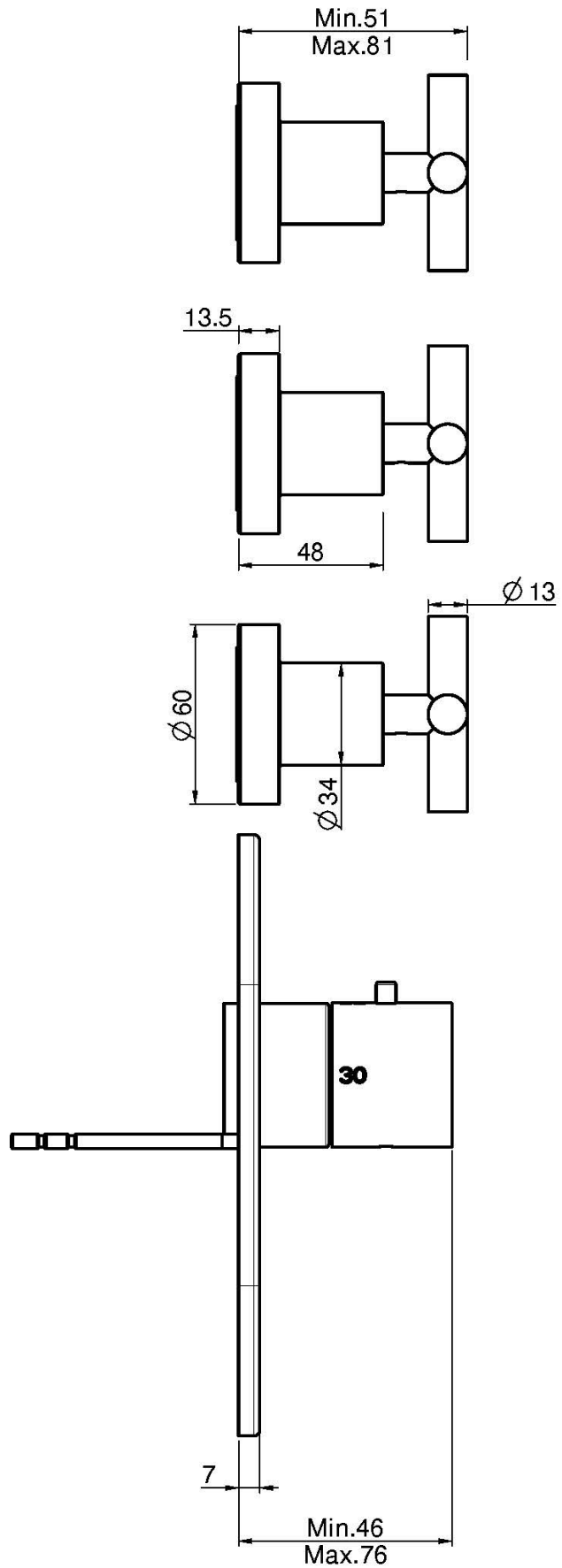
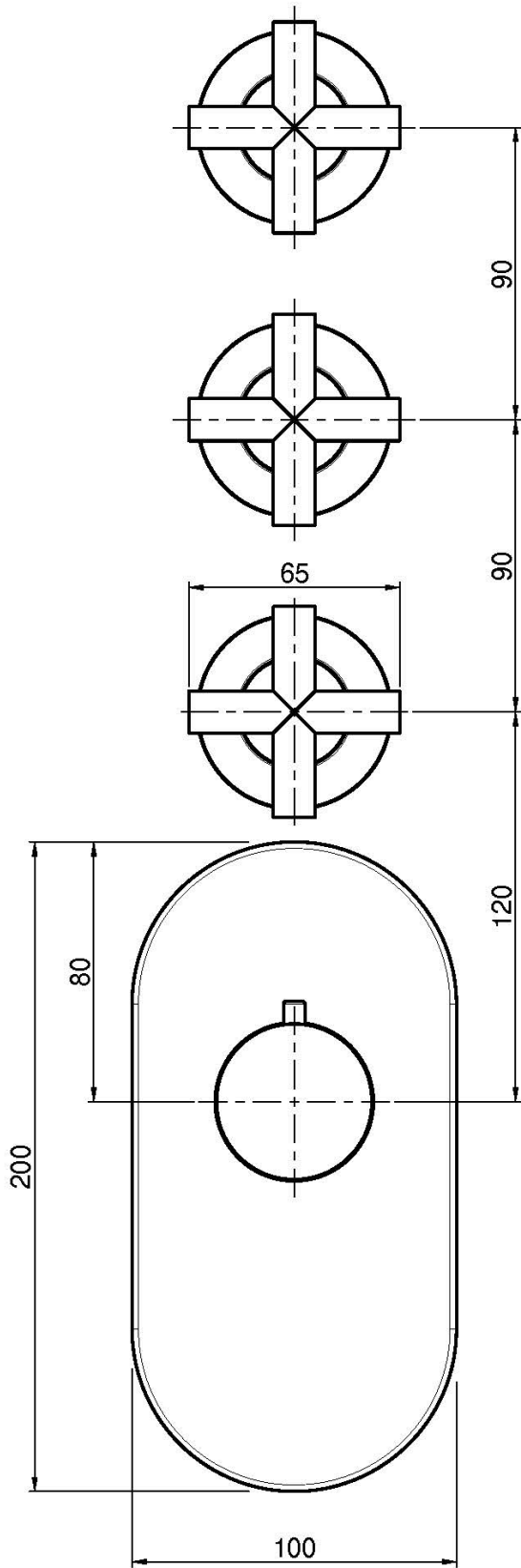

This drawing is the property of FIMA Carlo Frattini. Any complete or partial reproduction, or any transmission to third party without FIMA Carlo Frattini authorization is forbidden.

