

Code F3229X7

**THERMOSTATIC MIXER FOR CONCEALED INSTALLATION WITH 2/3 OUTLETS DIVERTER**

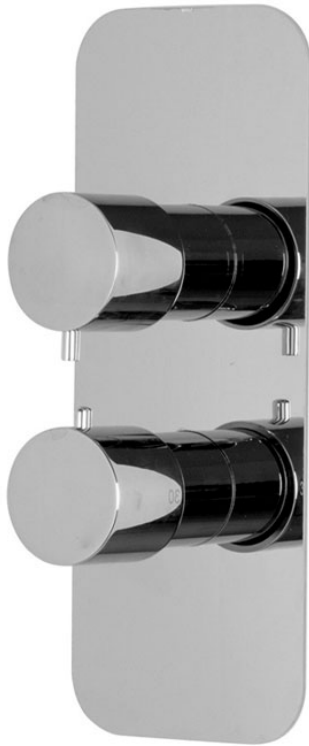











- exposed part only
- 2/3 outlets diverter
- **built-in part to be ordered separately**

IMAGE



See the general sales conditions in our current pricelist

Finishing

-  CHROM  
CR
-  HL
-  HS
-  ZL
-  ZS
-  BRUSHED NICKEL  
SN
-  BLACK CHROME  
CN
-  BRUSHED BLACK CHROME  
CS
-  WHITE MATT  
BS
-  BLACK MATT  
NS
-  GOLD  
OR
-  BRUSHED GOLD  
OS

PRODUCTS NEEDED TO BE ORDERED SEPARATELY

Built-in part



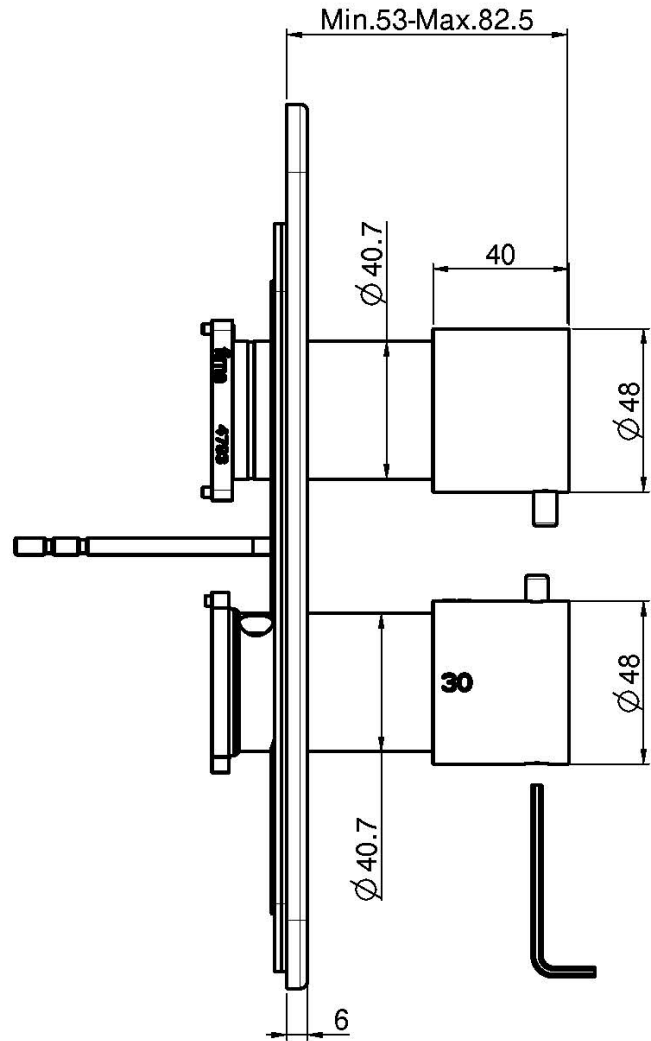
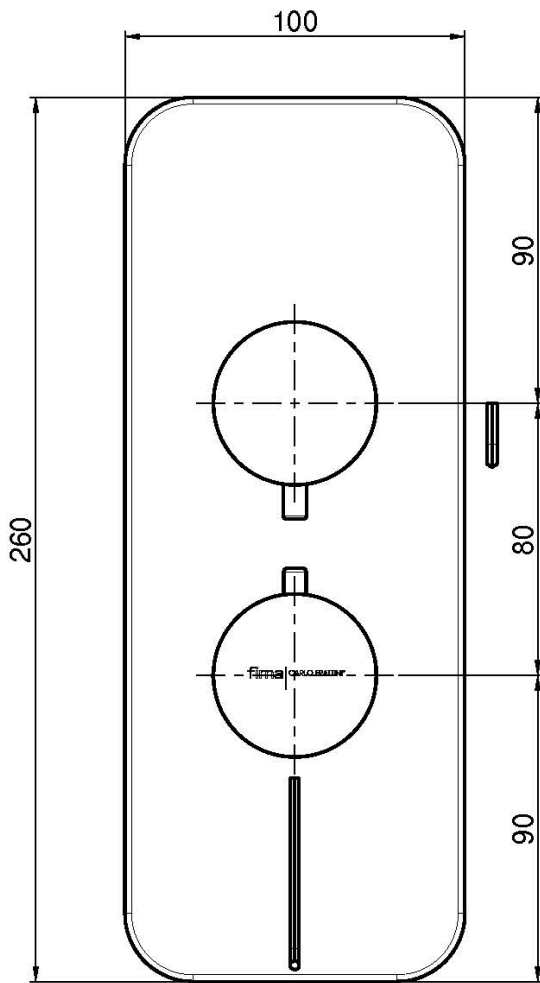

This drawing is the property of FIMA Carlo Frattini. Any complete or partial reproduction, or any transmission to third party without FIMA Carlo Frattini authorization is forbidden.

