

Code F3229X7

THERMOSTATIC MIXER FOR CONCEALED INSTALLATION WITH 2/3 OUTLETS DIVERTER

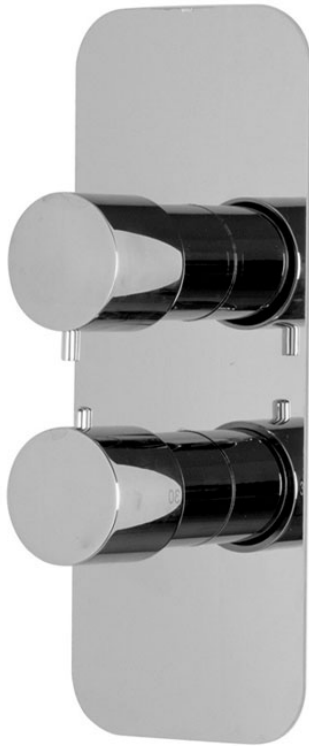











- exposed part only
- 2/3 outlets diverter
- **built-in part to be ordered separately**

IMAGE



See the general sales conditions in our current pricelist

Finishing

-  CHROM
CR
-  GOLD
HL
-  BRUSHED GOLD
HS
-  BLACK CHROME
ZL
-  BRUSHED BLACK CHROME
ZS
-  BRUSHED NICKEL
SN
-  BLACK CHROME
CN
-  BRUSHED BLACK CHROME
CS
-  WHITE MATT
BS
-  BLACK MATT
NS
-  GOLD
OR
-  BRUSHED GOLD
OS

PRODUCTS NEEDED TO BE ORDERED SEPARATELY

Built-in part



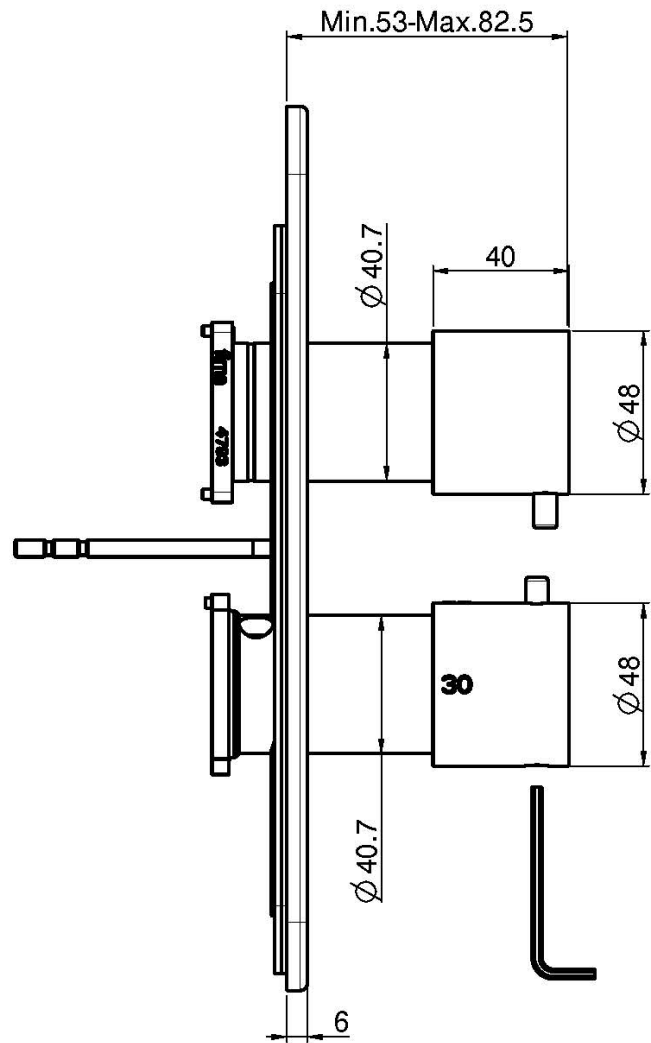
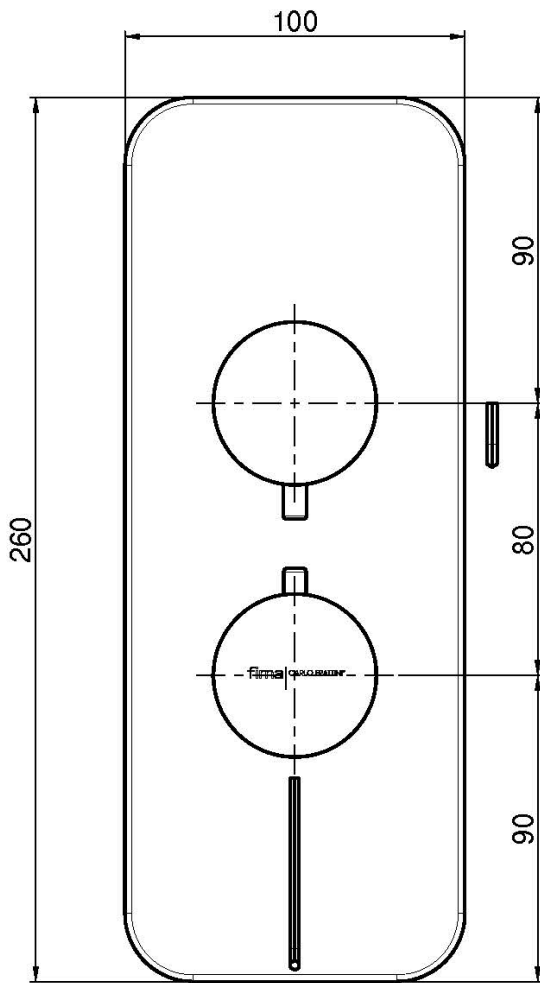

This drawing is the property of FIMA Carlo Frattini. Any complete or partial reproduction, or any transmission to third party without FIMA Carlo Frattini authorization is forbidden.

