







Code F3189X7

THERMOSTATIC MIXER FOR CONCEALED INSTALLATION WITH 2/3 OUTLETS DIVERTER

- **HANDLE SOLD SEPARATELY**
- exposed part only
- 2/3 outlets diverter
- **built-in part to be ordered separately**

TO COMPLETE THIS PRODUCT PLEASE ORDER NR. 1 HANDLE S2

Finishing

-  CHROM
CR
-  HL
-  HS
-  ZL
-  ZS
-  BRUSHED NICKEL
SN
-  BLACK CHROME
CN
-  BRUSHED BLACK CHROME
CS
-  WHITE MATT
BS
-  BLACK MATT
NS
-  GOLD
OR
-  BRUSHED GOLD
OS

IMAGE



PRODUCTS NEEDED TO BE ORDERED SEPARATELY

Built-in part



Handle S2



See the general sales conditions in our current pricelist

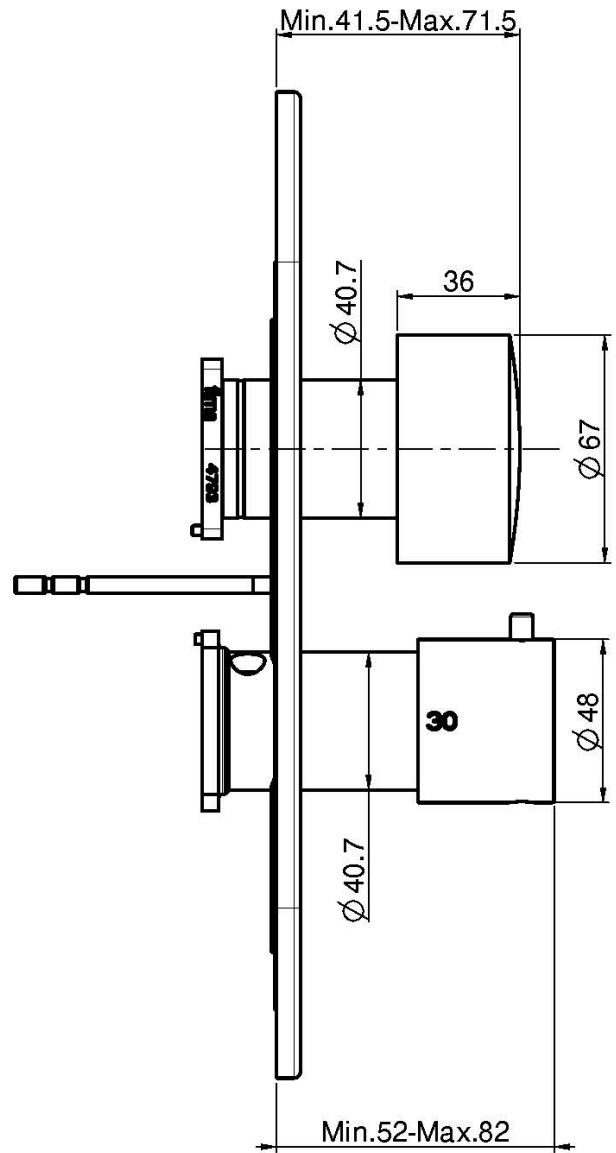
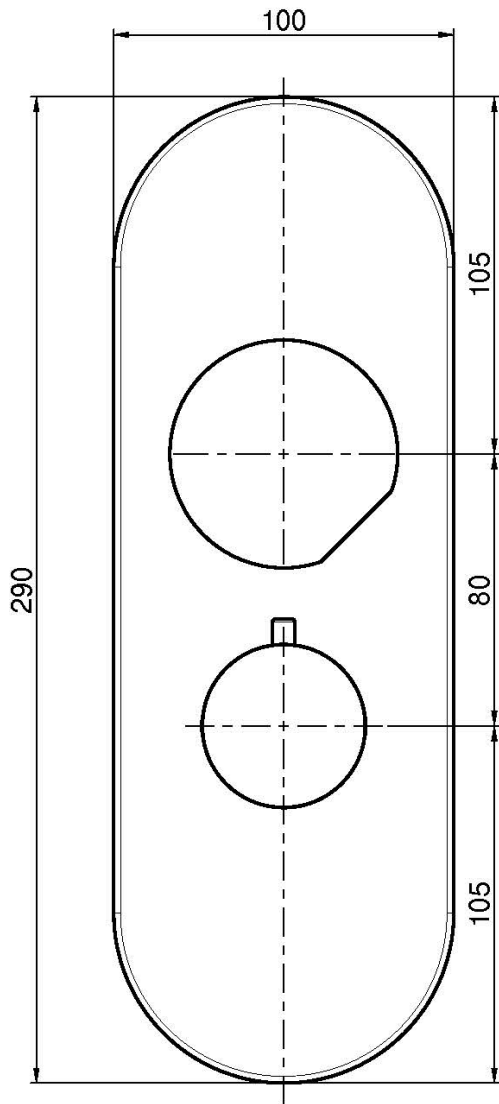

This drawing is the property of FIMA Carlo Frattini. Any complete or partial reproduction, or any transmission to third party without FIMA Carlo Frattini authorization is forbidden.

