







Code F3189X7

**THERMOSTATIC MIXER FOR CONCEALED INSTALLATION WITH 2/3 OUTLETS DIVERTER**

- **HANDLE SOLD SEPARATELY**
- exposed part only
- 2/3 outlets diverter
- **built-in part to be ordered separately**

TO COMPLETE THIS PRODUCT PLEASE ORDER NR. 1 HANDLE S2

**Finishing**

-  CHROM  
CR
-  HL
-  HS
-  ZL
-  ZS
-  BRUSHED NICKEL  
SN
-  BLACK CHROME  
CN
-  BRUSHED BLACK CHROME  
CS
-  WHITE MATT  
BS
-  BLACK MATT  
NS
-  GOLD  
OR
-  BRUSHED GOLD  
OS

**IMAGE**



**PRODUCTS NEEDED TO BE ORDERED SEPARATELY**

[Built-in part](#)



[Handle S2](#)



See the general sales conditions in our current pricelist

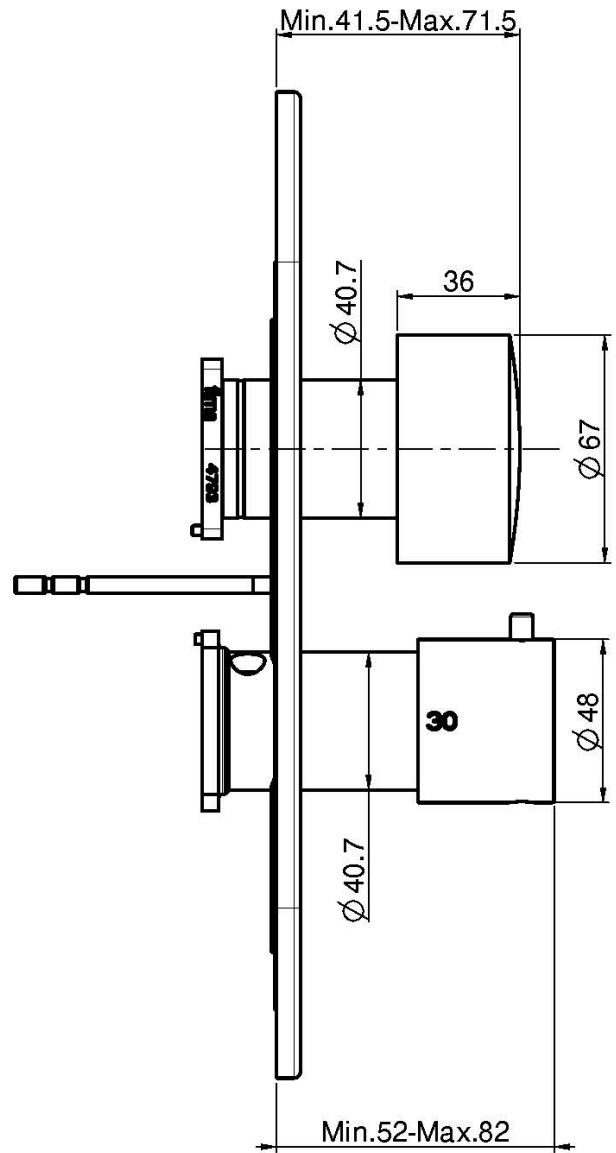
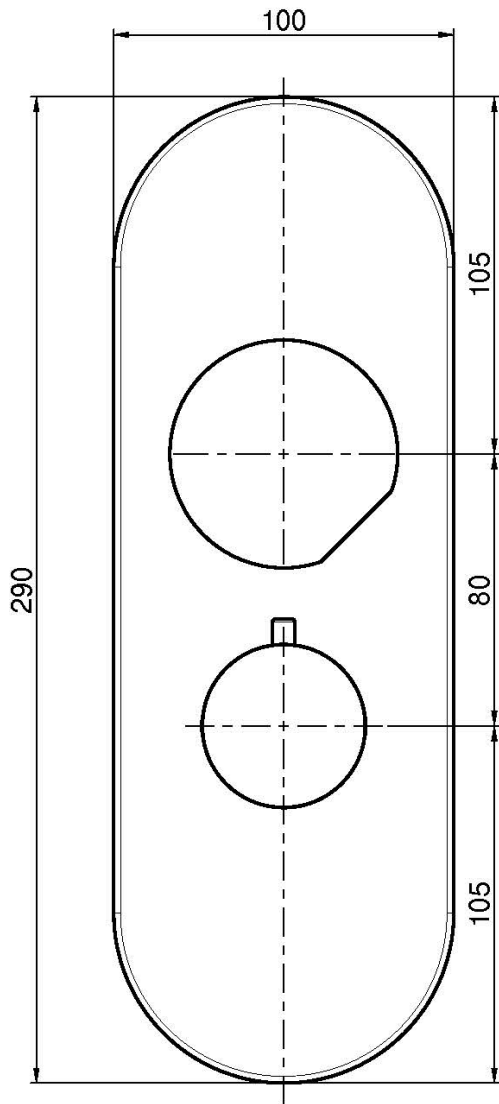

This drawing is the property of FIMA Carlo Frattini. Any complete or partial reproduction, or any transmission to third party without FIMA Carlo Frattini authorization is forbidden.

