

Code F4039X1

**THERMOSTATIC SINGLE LEVER
BATH/SHOWER MIXER FOR CONCEALED
INSTALLATION**













- exposed part only
- **built-in part to be ordered separately**

IMAGE



See the general sales conditions in our current pricelist

Finishing

-  CHROM
CR
-  HL
-  HS
-  ZL
-  ZS
-  SN
-  CN
-  CS
-  BS
-  NS
-  OR
-  OS

**PRODUCTS NEEDED TO BE ORDERED
SEPARATELY**

Built-in part



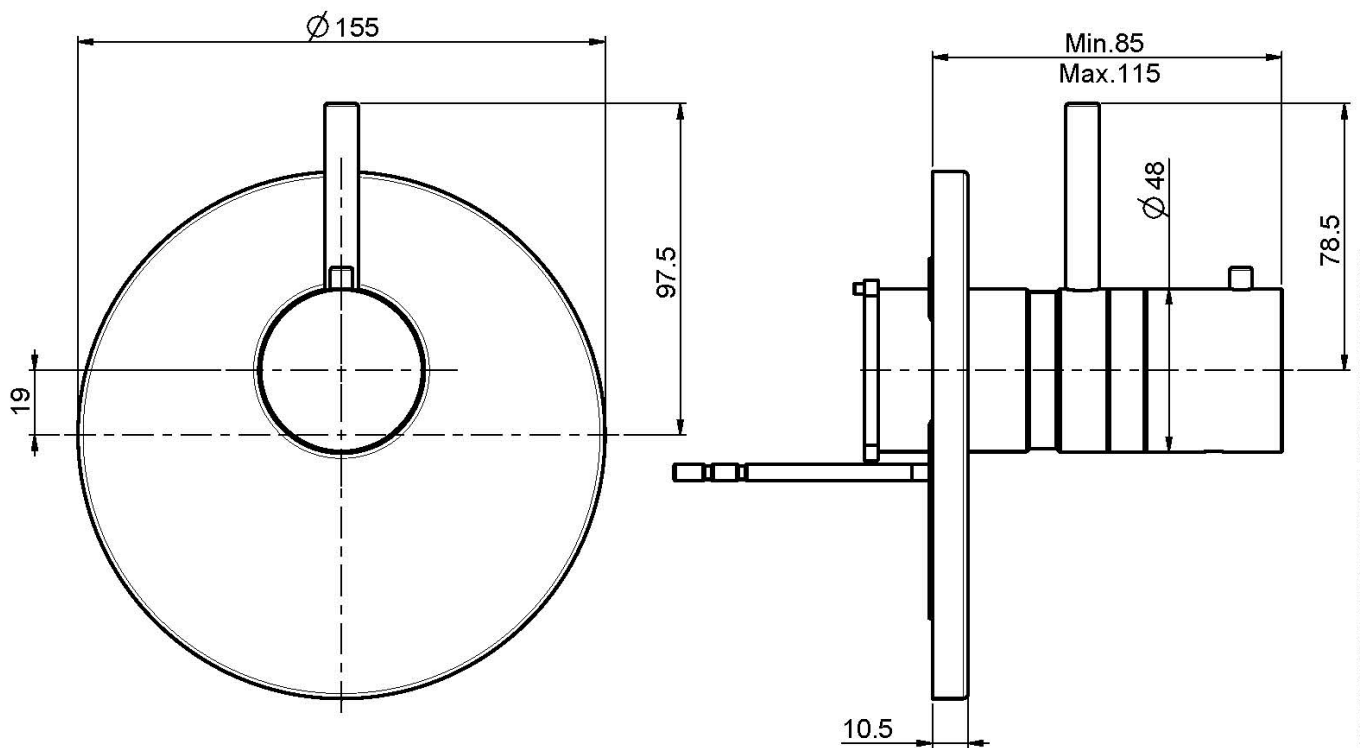

This drawing is the property of FIMA Carlo Frattini. Any complete or partial reproduction, or any transmission to third party without FIMA Carlo Frattini authorization is forbidden.

