

Code F3191A









THREE-HOLES BASIN MIXER WITH SWIVEL SPOUT

HANDLES SOLD SEPARATELY

- n. 2 flexible hoses
- swivel spout Ø 10 mm
- 1"1/4 brass click clack waste

TO COMPLETE THIS PRODUCT PLEASE ORDER NR. 1 PAIR OF HANDLES S4 OR NR.2 HANDLES S2

Finishing

-  CHROM
CR
-  HL
-  HS
-  ZL
-  ZS
-  BRUSHED NICKEL
SN
-  BLACK CHROME
CN
-  BRUSHED BLACK CHROME
CS
-  WHITE MATT
BS
-  BLACK MATT
NS
-  GOLD
OR
-  BRUSHED GOLD
OS

IMAGE



PRODUCTS NEEDED TO BE ORDERED SEPARATELY

[Handle S2](#)



[Pair of handles S4 for three-holes basin mixer](#)



See the general sales conditions in our current pricelist

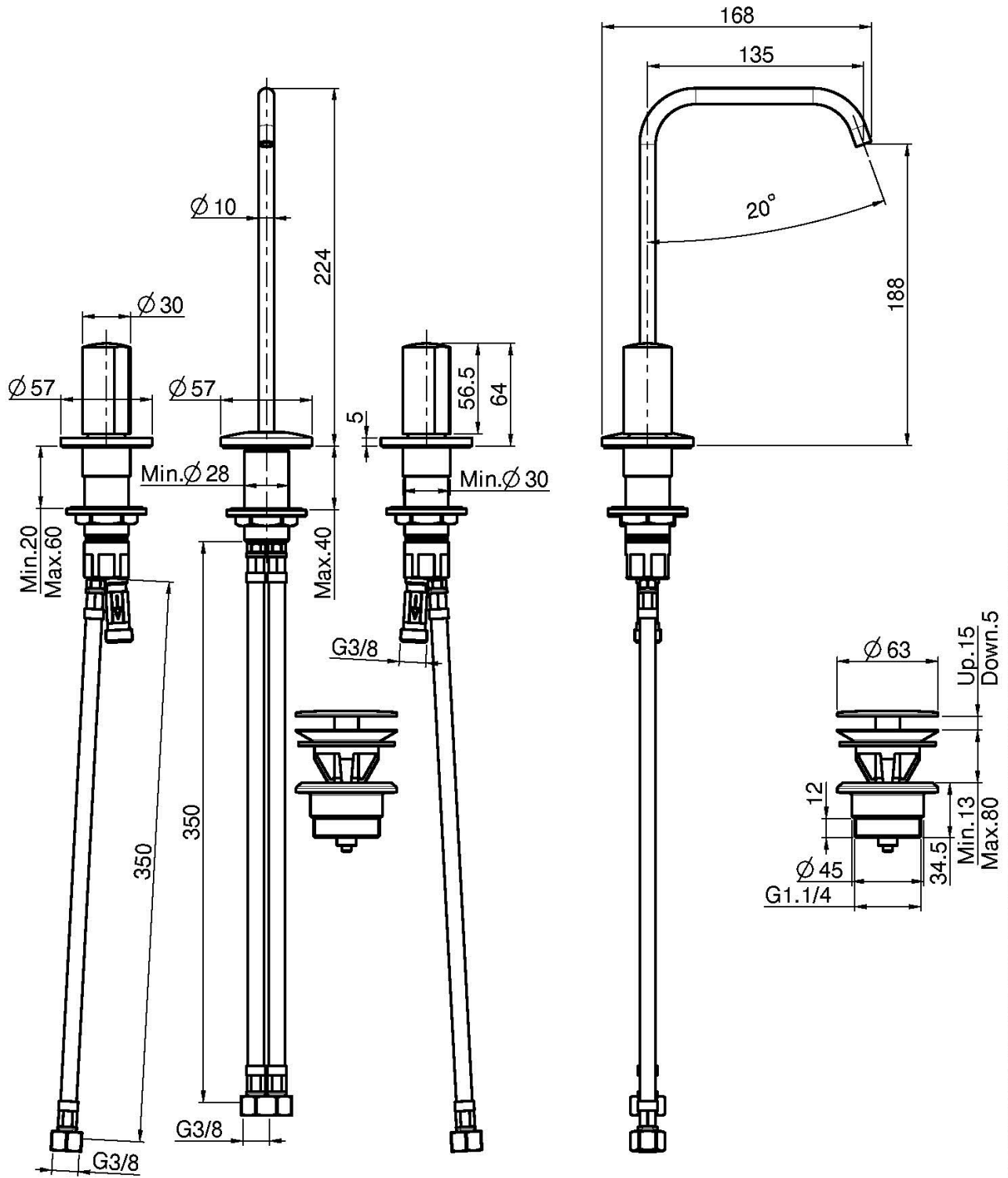

This drawing is the property of FIMA Carlo Frattini. Any complete or partial reproduction, or any transmission to third party without FIMA Carlo Frattini authorization is forbidden.

