

Code F5323/1









VOLUME CONTROL VALVE 1/2"

- exposed part only
- **built-in part to be ordered separately**

IMAGE



Finishing

-  CHROM
CR
-  HL
-  HS
-  BRUSHED NICKEL
SN
-  BLACK CHROME
CN
-  BRUSHED BLACK CHROME
CS
-  WHITE MATT
BS
-  BLACK MATT
NS

PRODUCTS NEEDED TO BE ORDERED SEPARATELY

Built-in part



See the general sales conditions in our current pricelist

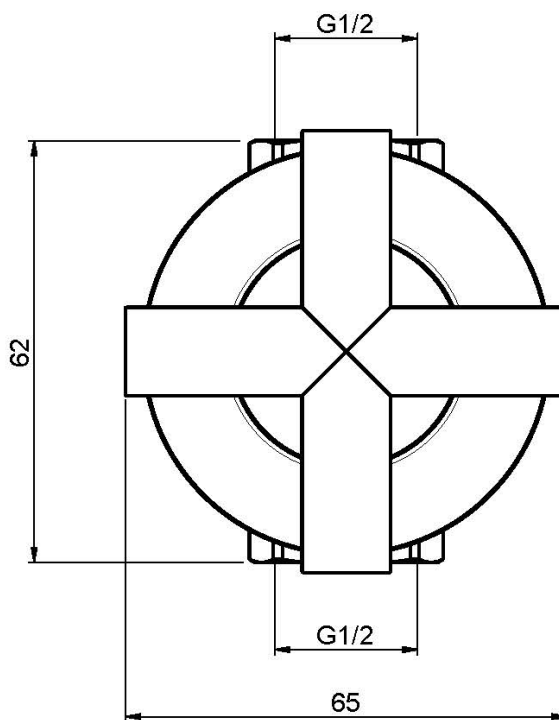
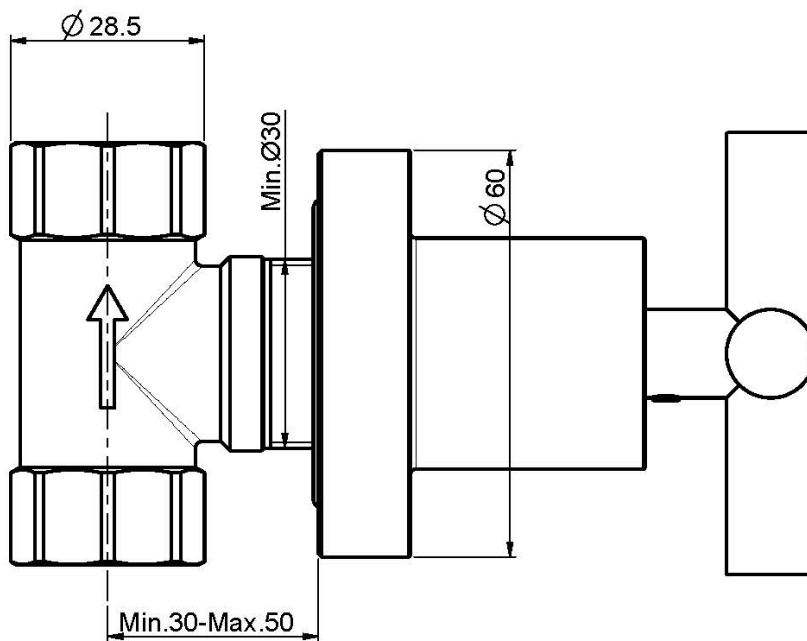

This drawing is the property of FIMA Carlo Frattini. Any complete or partial reproduction, or any transmission to third party without FIMA Carlo Frattini authorization is forbidden.

