

Code F5621

## WASH BASIN MIXER





• **COVER TO BE ORDERED SEPARATELY**

- n. 2 flexible hoses
- 1"1/4 brass click clack waste













## IMAGE



## Texture

-  H COLLECTION
-  V COLLECTION
-  V COLLECTION
-  X COLLECTION

## Finishing

-  CHROM  
CR
-  HL
-  HS
-  ZL
-  ZS
-  BRUSHED NICKEL  
SN
-  BLACK CHROME  
CN
-  BRUSHED BLACK CHROME  
CS
-  WHITE MATT  
BS
-  BLACK MATT  
NS
-  GOLD  
OR
-  BRUSHED GOLD  
OS



See the general sales conditions in our current pricelist

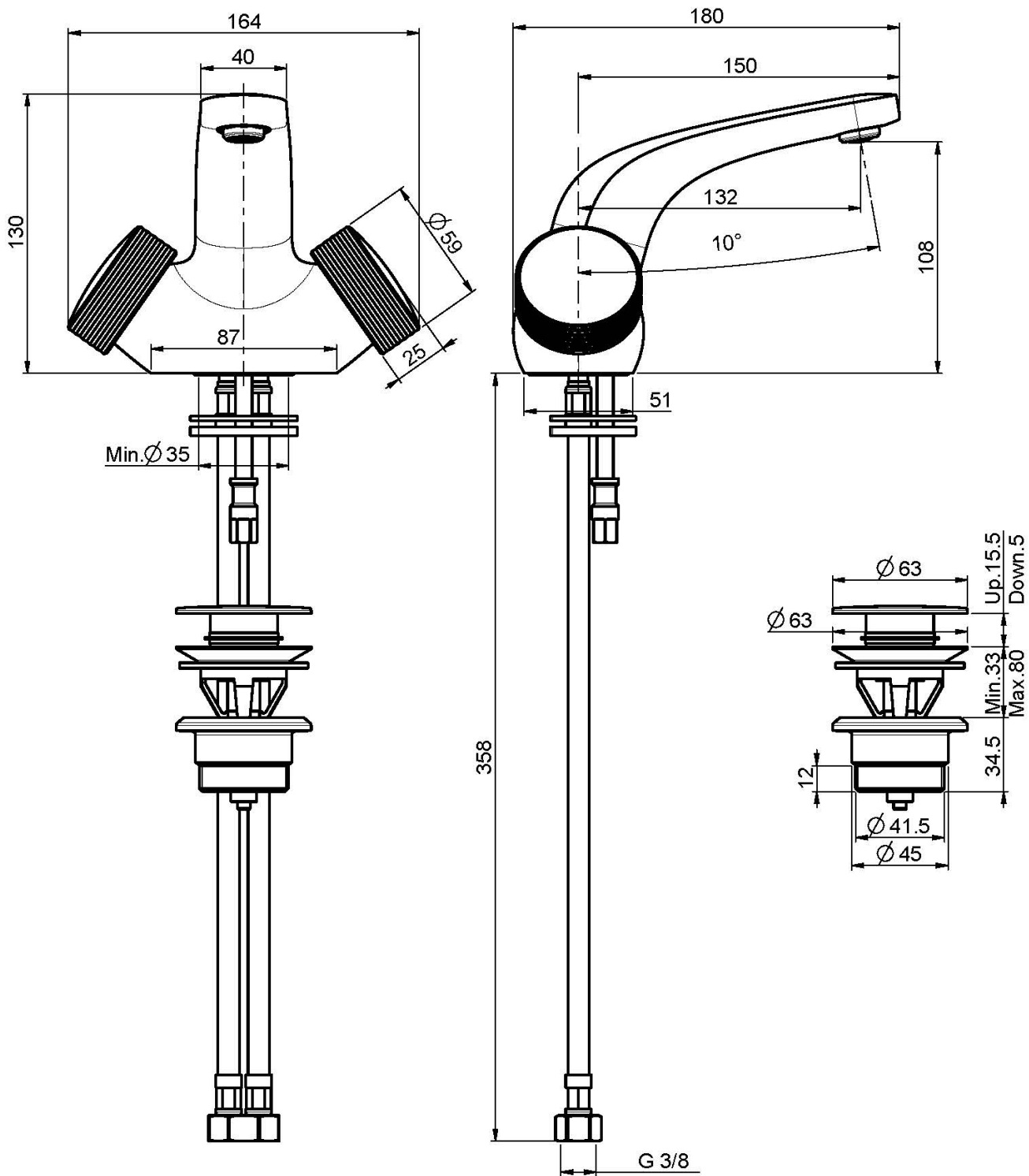

This drawing is the property of FIMA Carlo Frattini. Any complete or partial reproduction, or any transmission to third party without FIMA Carlo Frattini authorization is forbidden.