

Codigo F5014

BATERÍA ENCIMERA PARA BAÑERA

- flexible nylon 1500 mm
- ducha con boquillas anti-cal
- desviador
- soporte ducha

IMAGEN



Acabados

-  CROMADO
CR
-  NÍQUEL SATINADO
SN
-  DORADO
OR
-  ORO SATINADO
OS
-  BRONCE
BR
-  COBRE ANTIGUO
RA

LOS PRODUCTOS DEBEN SER PEDIDOS
POR SEPARADO

[Placa en acero
inox](#)



Consulte las condiciones generales de venta en nuestra lista
de precios aplicable

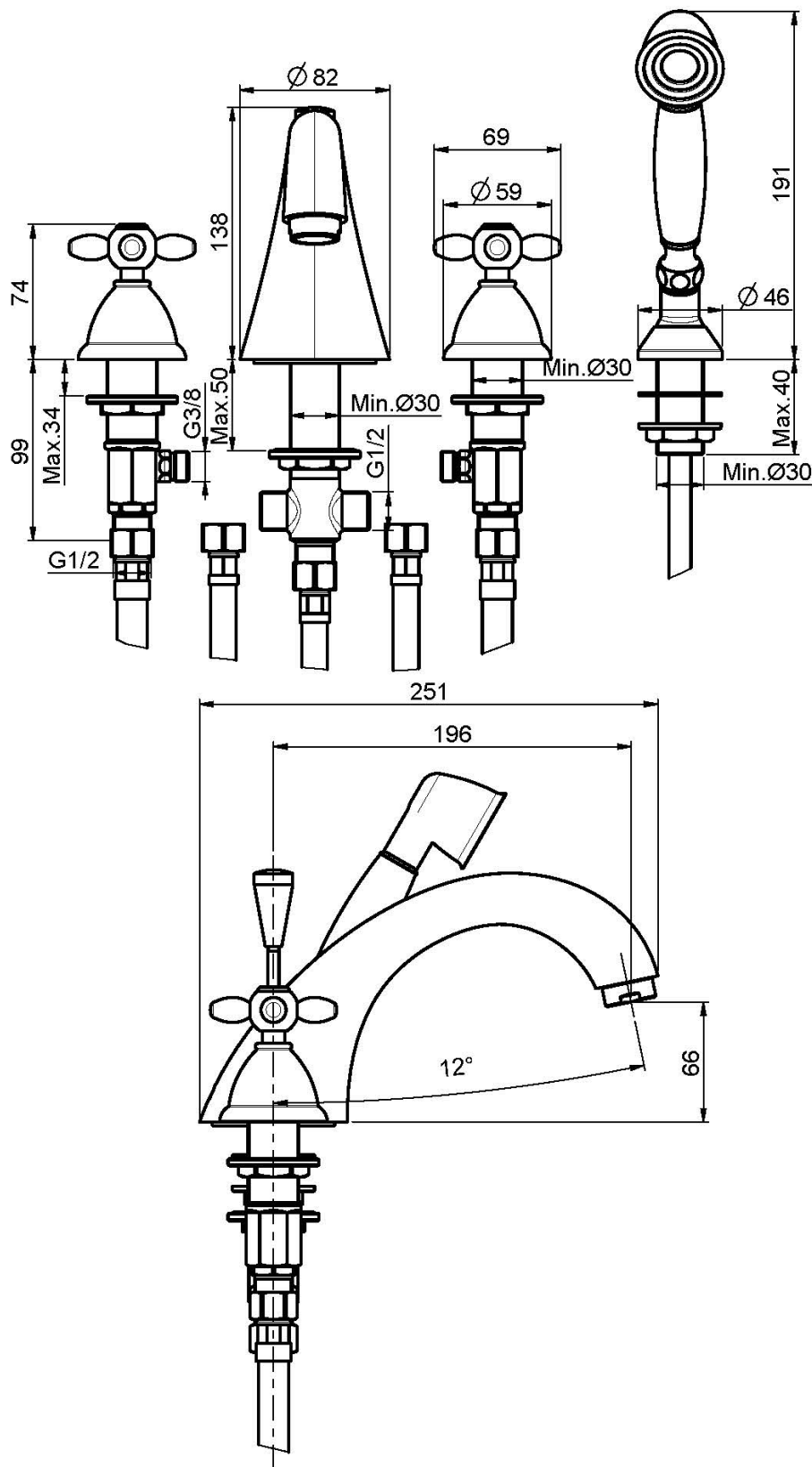

This drawing is the property of FIMA Carlo Frattini. Any complete or partial reproduction, or any transmission to third party without FIMA Carlo Frattini authorization is forbidden.

