

Codigo F5084

BATERÍA PARA BAÑERA CON SET DE DUCHA

- n. 2 excéntricas 1/2"
- flexible de latón 1500 mm
- ducha con boquillas anti-cal
- desviador

Acabados

-  CROMADO
CR
-  NÍQUEL SATINADO
SN
-  DORADO
OR
-  ORO SATINADO
OS
-  BRONCE
BR
-  COBRE ANTIGUO
RA

IMAGEN



Consulte las condiciones generales de venta en nuestra lista de precios aplicable

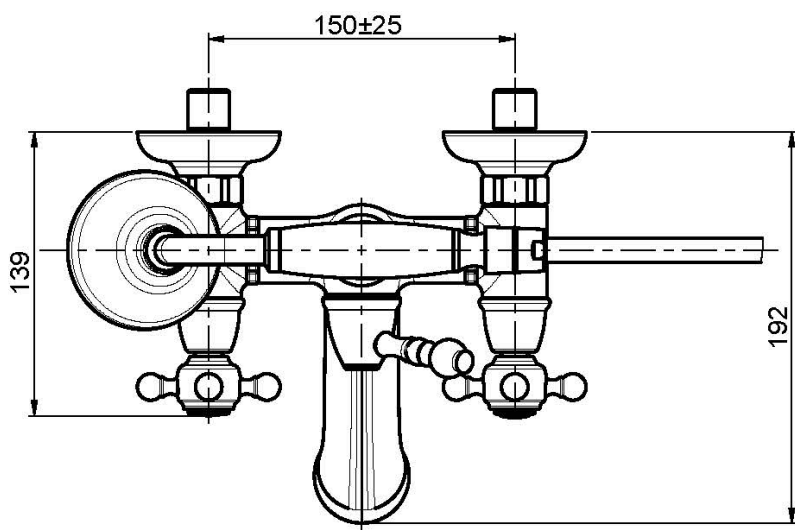
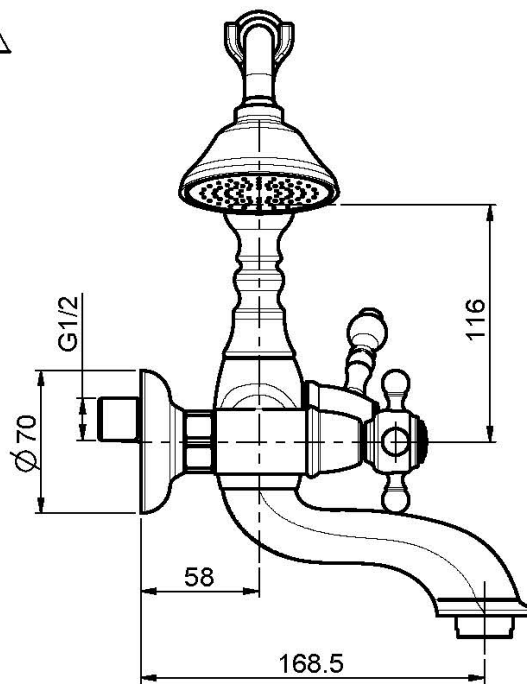
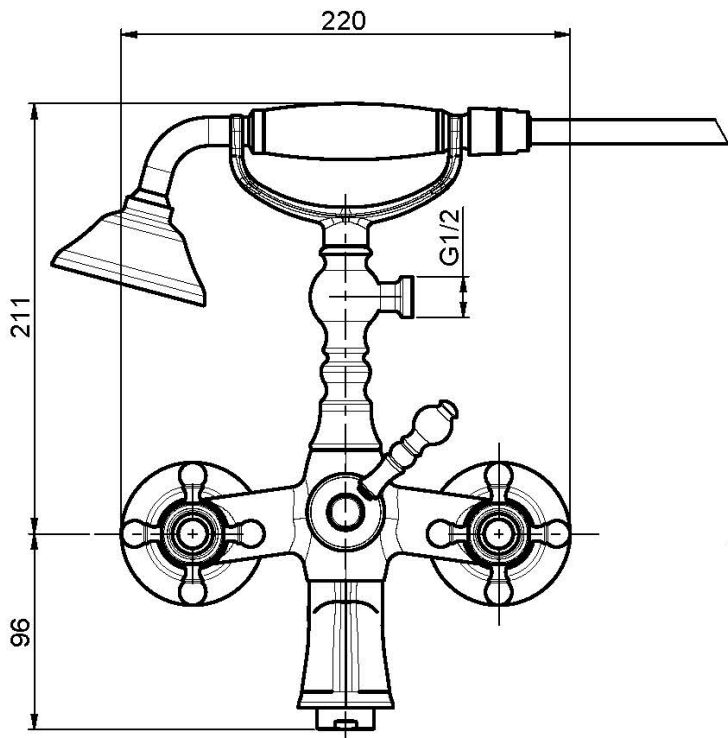

This drawing is the property of FIMA Carlo Frattini. Any complete or partial reproduction, or any transmission to third party without FIMA Carlo Frattini authorization is forbidden.