

Codigo F5055

BATERÍA PARA DUCHA CON SET DE DUCHA

- n. 2 excéntricas 1/2"
- flexible de latón 1500 mm
- ducha con boquillas anti-cal
- soporte ducha

Acabados

-  CROMADO
CR
-  NÍQUEL SATINADO
SN
-  DORADO
OR
-  ORO SATINADO
OS
-  BRONCE
BR
-  COBRE ANTIGUO
RA

IMAGEN



Consulte las condiciones generales de venta en nuestra lista de precios aplicable

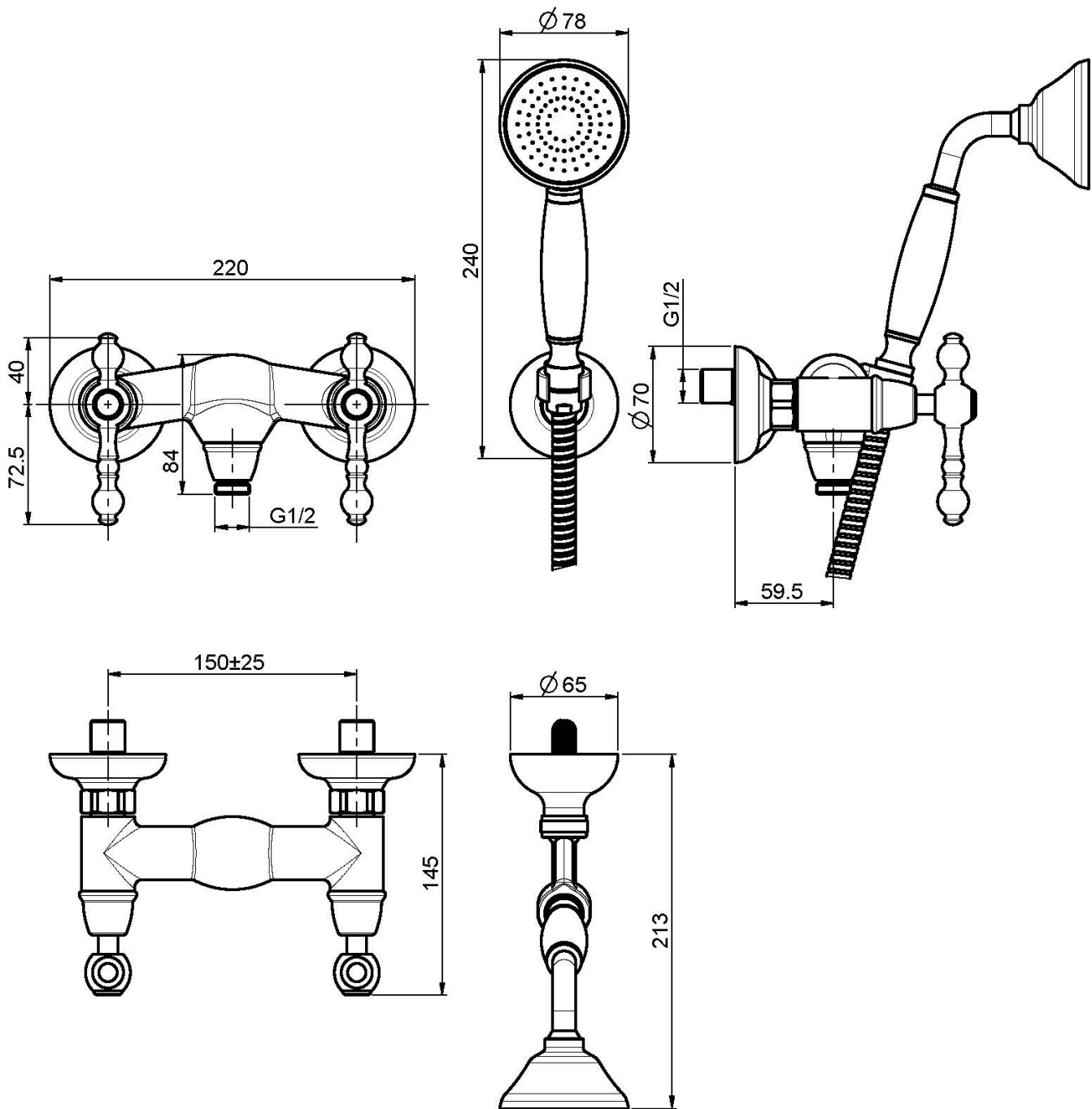

This drawing is the property of FIMA Carlo Frattini. Any complete or partial reproduction, or any transmission to third party without FIMA Carlo Frattini authorization is forbidden.