

Codigo F5085

## BATERÍA PARA DUCHA CON SET DE DUCHA

- n. 2 excéntricas 1/2"
- flexible de latón 1500 mm
- ducha con boquillas anti-cal
- soporte ducha

Acabados

-  CROMADO  
CR
-  NÍQUEL SATINADO  
SN
-  DORADO  
OR
-  ORO SATINADO  
OS
-  BRONCE  
BR
-  COBRE ANTIGUO  
RA

IMAGEN



Consulte las condiciones generales de venta en nuestra lista de precios aplicable

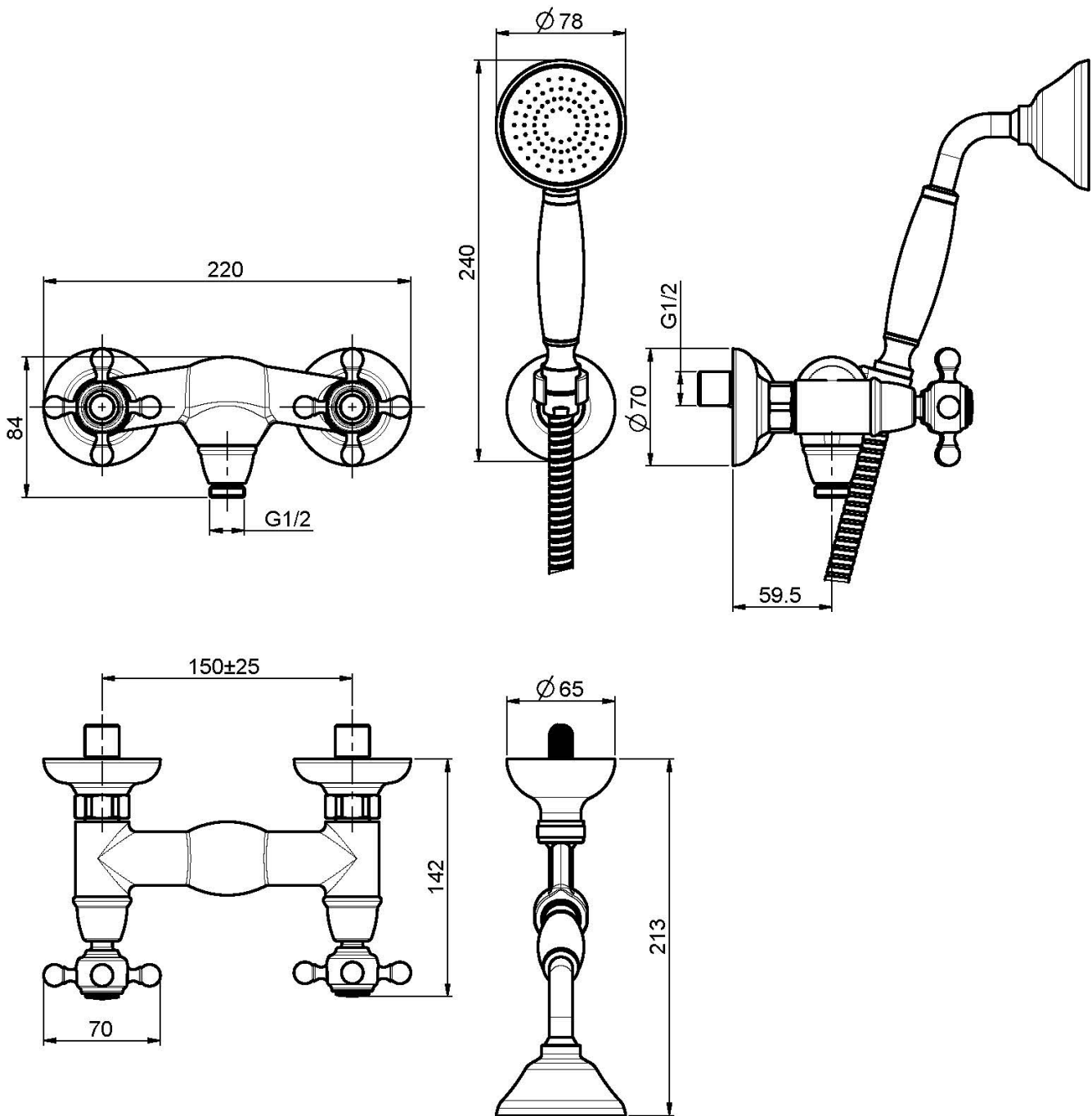

This drawing is the property of FIMA Carlo Frattini. Any complete or partial reproduction, or any transmission to third party without FIMA Carlo Frattini authorization is forbidden.