

Codigo F4049X2

MEZCLADOR TERMOSTÁTICO EMPOTRADO

- sólo parte exterior
- **parte empotrada a pedir por separado**

IMAGEN



Acabados

-  CROMADO
CR
-  HL
-  HS
-  ZL
-  ZS
-  NÍQUEL SATINADO
SN
-  CROMO NEGRO
CN
-  CROMO NEGRO SATINADO
CS
-  BLANCO MATE
BS
-  NEGRO MATE
NS
-  DORADO
OR
-  ORO SATINADO
OS



Consulte las condiciones generales de venta en nuestra lista de precios aplicable

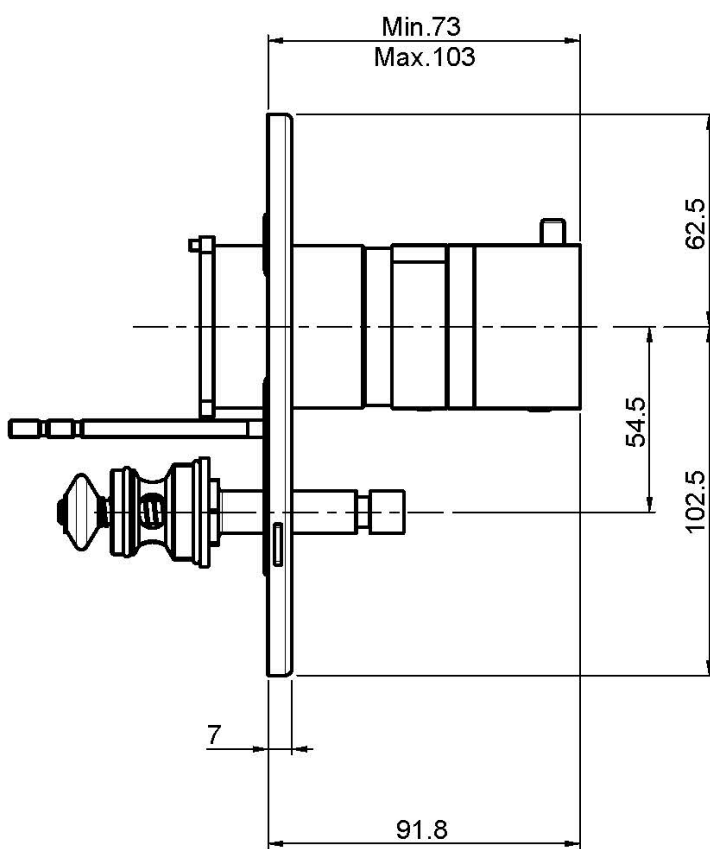
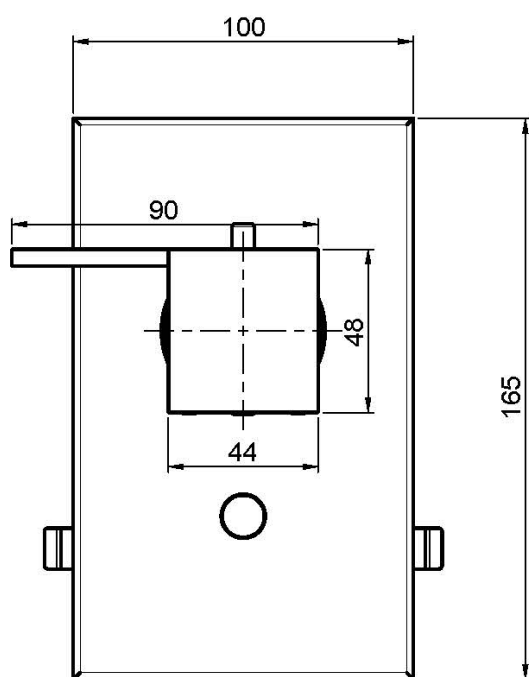

This drawing is the property of FIMA Carlo Frattini. Any complete or partial reproduction, or any transmission to third party without FIMA Carlo Frattini authorization is forbidden.