

Codigo F5113X2

## MEZCLADOR TERMOSTÁTICO EMPOTRADO

- instalación horizontal o vertical
- sólo parte exterior
- 2 llaves de paso
- maneta graduada con bloqueo de seguridad
- **parte empotrada a pedir por separado**

IMAGEN



Acabados

-  CROMADO  
CR
-  NÍQUEL SATINADO  
SN
-  DORADO  
OR
-  ORO SATINADO  
OS
-  BRONCE  
BR
-  COBRE ANTIGUO  
RA

LOS PRODUCTOS DEBEN SER PEDIDOS  
POR SEPARADO

[Cuerpo empotrado](#)



Consulte las condiciones generales de venta en nuestra lista  
de precios aplicable

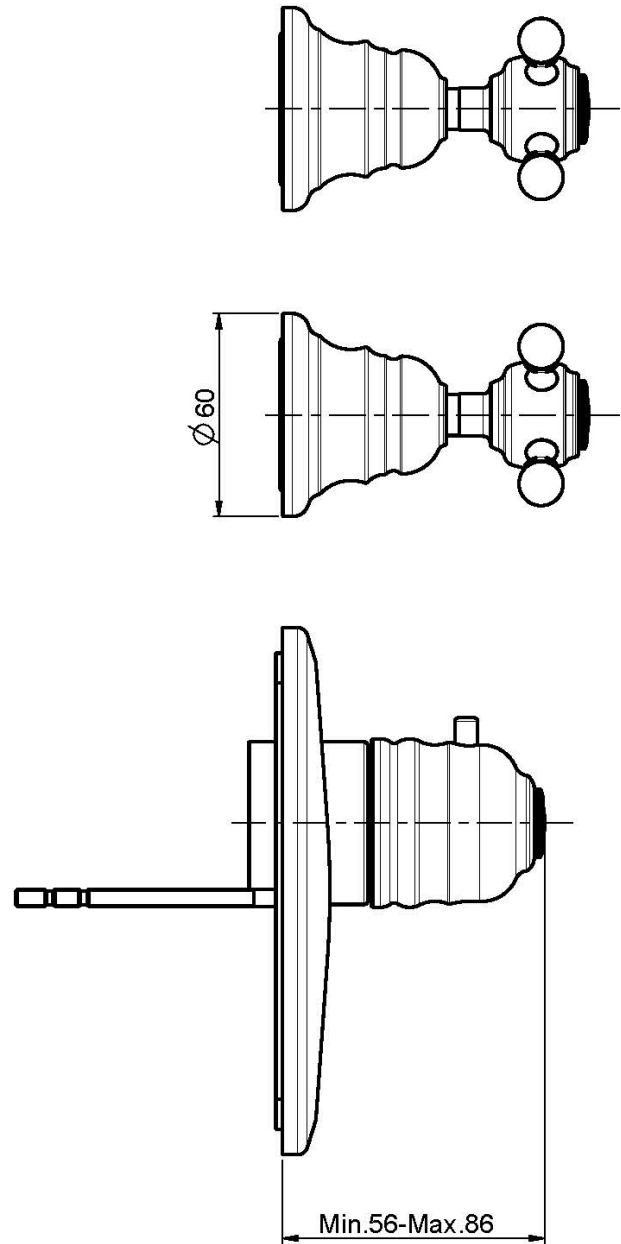
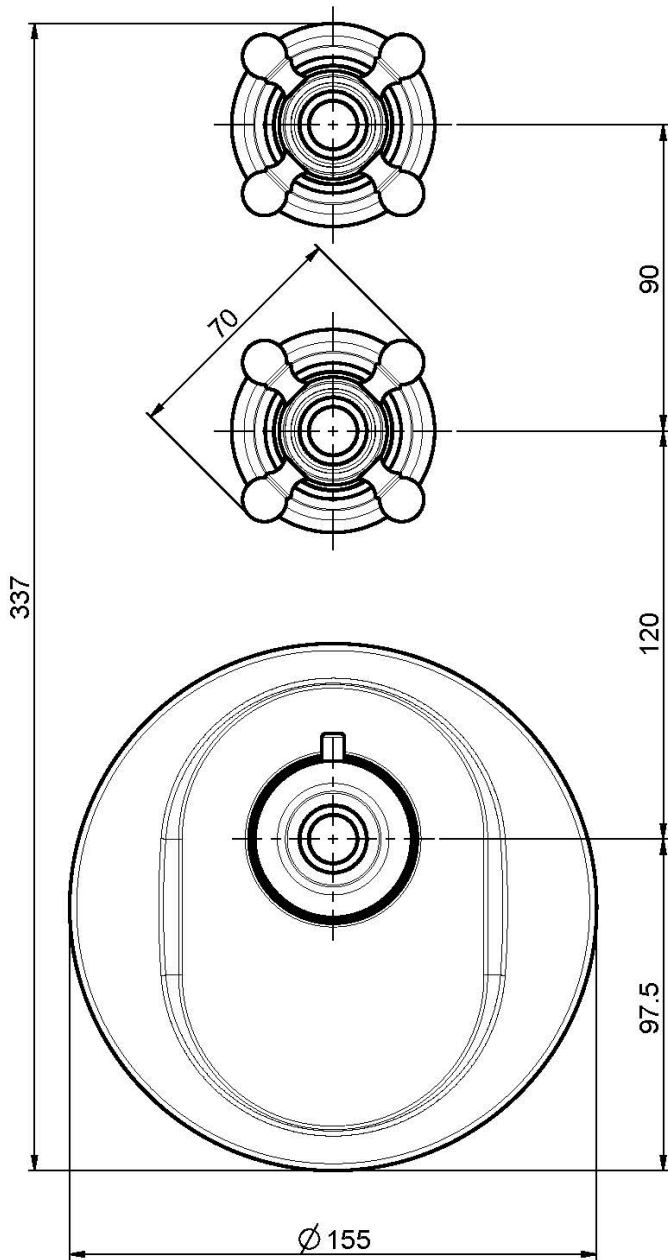

This drawing is the property of FIMA Carlo Frattini. Any complete or partial reproduction, or any transmission to third party without FIMA Carlo Frattini authorization is forbidden.

