

Codigo F5113X3

MEZCLADOR TERMOSTÁTICO EMPOTRADO

- instalación horizontal o vertical
- sólo parte exterior
- 3 llaves de paso
- maneta graduada con bloqueo de seguridad
- **parte empotrada a pedir por separado**

Acabados

-  CROMADO
CR
-  NÍQUEL SATINADO
SN
-  DORADO
OR
-  ORO SATINADO
OS
-  BRONCE
BR
-  COBRE ANTIGUO
RA

IMAGEN



LOS PRODUCTOS DEBEN SER PEDIDOS
POR SEPARADO

Cuerpo empotrado



Consulte las condiciones generales de venta en nuestra lista
de precios aplicable

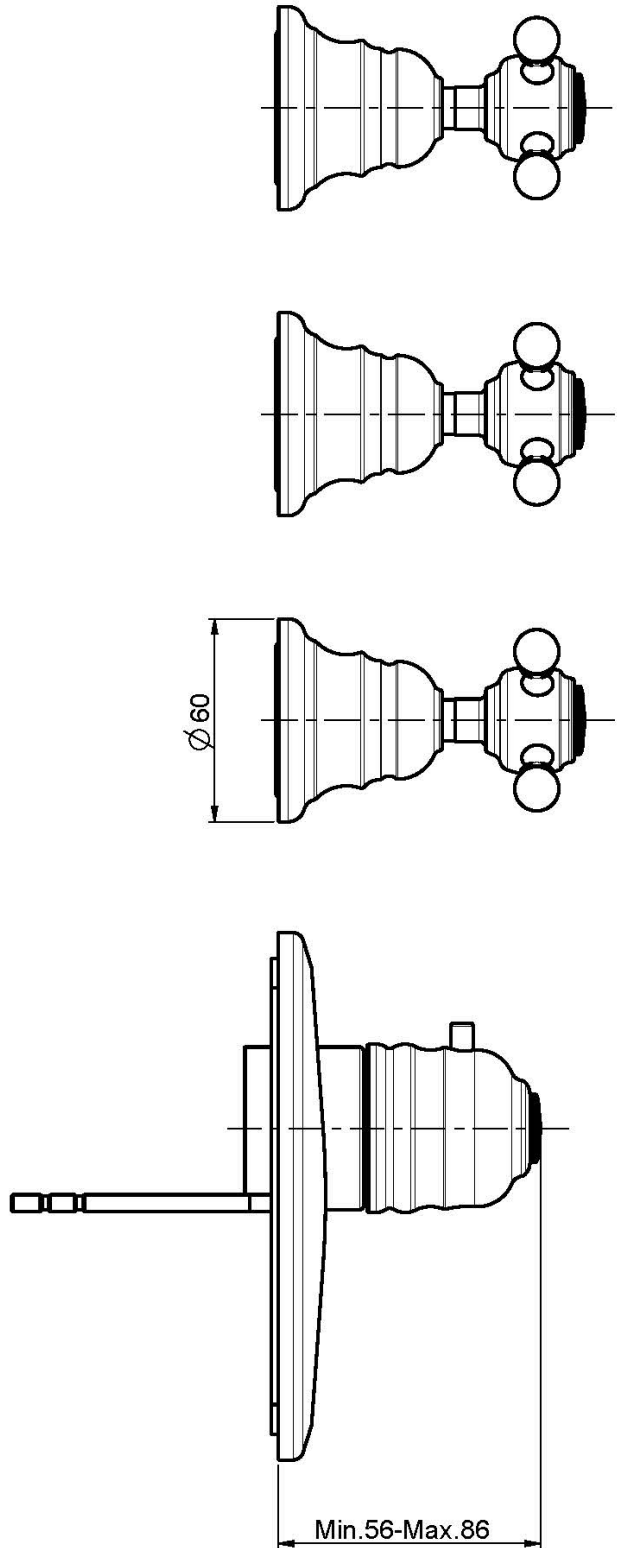
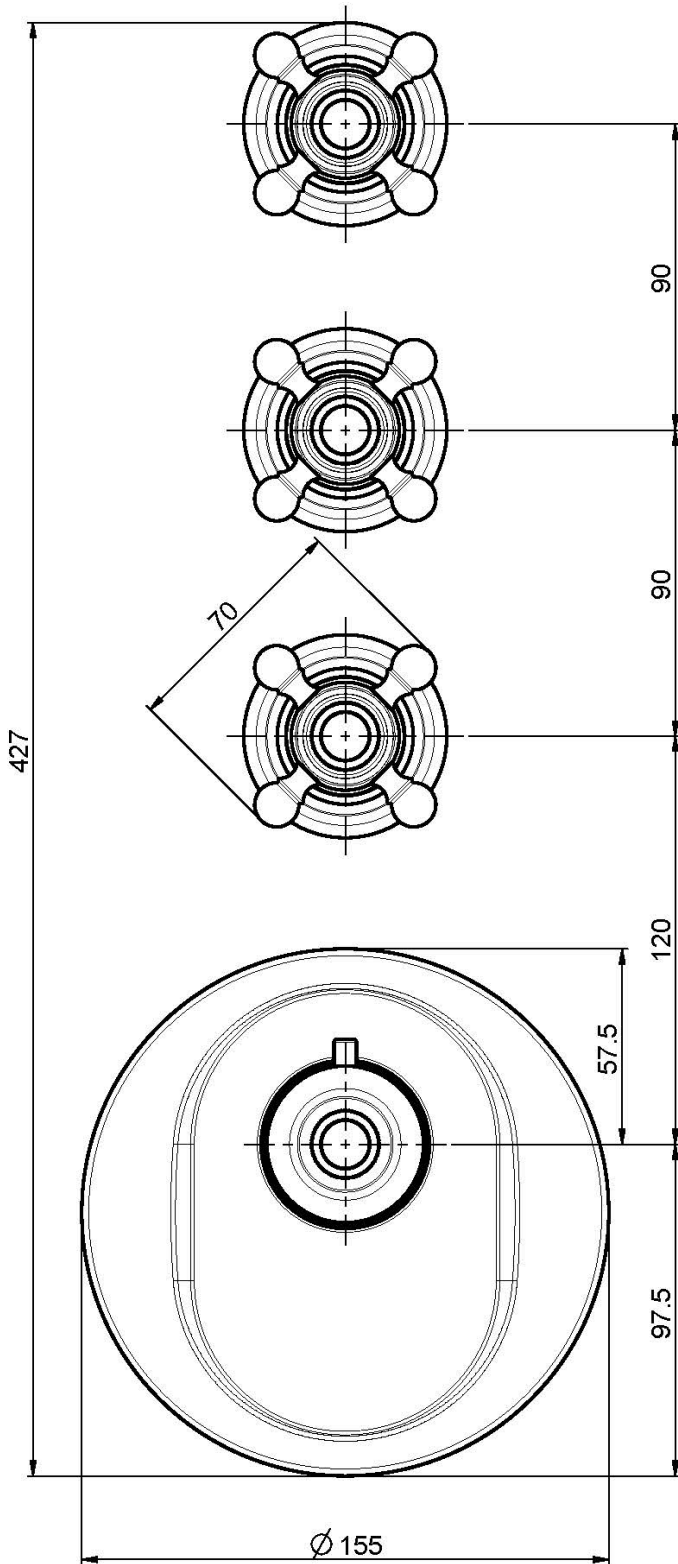

This drawing is the property of FIMA Carlo Frattini. Any complete or partial reproduction, or any transmission to third party without FIMA Carlo Frattini authorization is forbidden.

