

Codigo F3939X7

MEZCLADOR TERMOSTÁTICO EMPOTRADO CON DESVIADOR 2/3 SALIDAS

- sólo parte exterior
- desviador 2/3 salidas
- **parte empotrada a pedir por separado**

IMAGEN



Consulte las condiciones generales de venta en nuestra lista de precios aplicable

Acabados

-  CROMADO
CR
-  HL
-  HS
-  ZL
-  ZS
-  NÍQUEL SATINADO
SN
-  CROMO NEGRO
CN
-  CROMO NEGRO SATINADO
CS
-  BLANCO MATE
BS
-  NEGRO MATE
NS
-  DORADO
OR
-  ORO SATINADO
OS

**LOS PRODUCTOS DEBEN SER PEDIDOS
POR SEPARADO**

Cuerpo empotrado



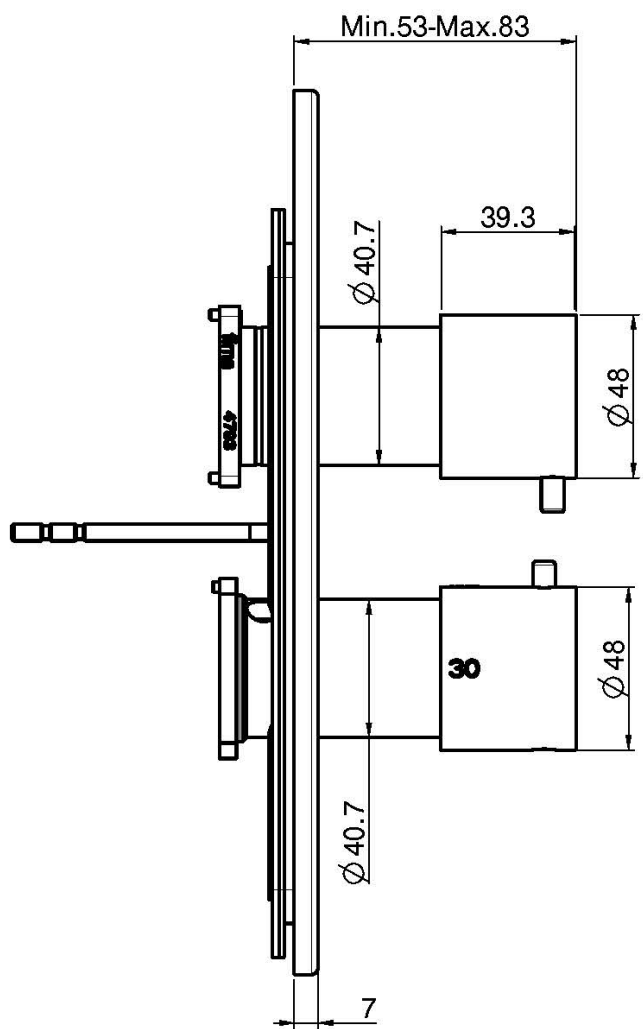
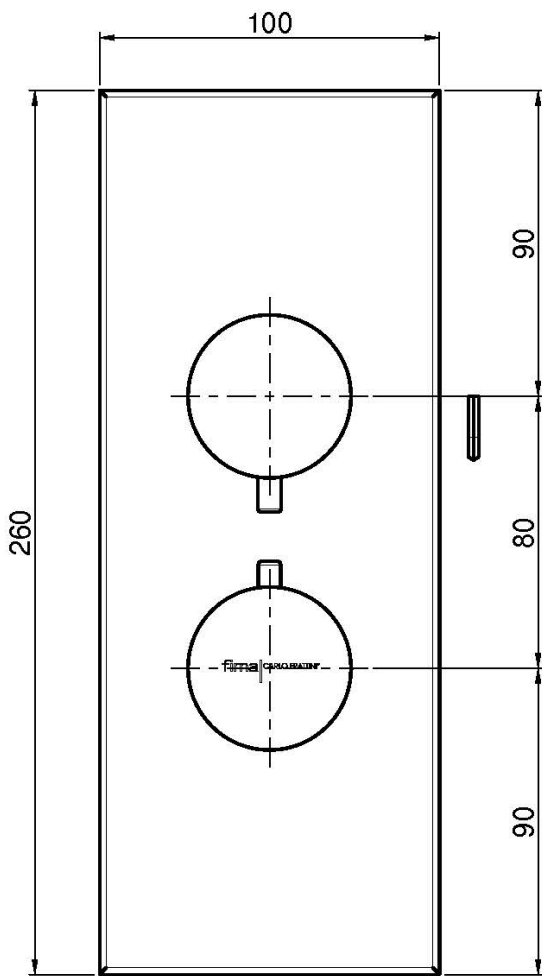

This drawing is the property of FIMA Carlo Frattini. Any complete or partial reproduction, or any transmission to third party without FIMA Carlo Frattini authorization is forbidden.

