

Codigo F5333X3

MEZCLADOR TERMOSTÁTICO EMPOTRADO MAXIMA

- 3 llaves de paso
- maneta graduada con bloqueo de seguridad
- sólo parte exterior
- instalación horizontal o vertical
- **parte empotrada a pedir por separado**

IMAGEN



Acabados

-  CROMADO
CR
-  HL
-  HS
-  NÍQUEL SATINADO
SN
-  CROMO NEGRO
CN
-  CROMO NEGRO SATINADO
CS
-  BLANCO MATE
BS
-  NEGRO MATE
NS

**LOS PRODUCTOS DEBEN SER PEDIDOS
POR SEPARADO**

Cuerpo empotrado



Consulte las condiciones generales de venta en nuestra lista
de precios aplicable

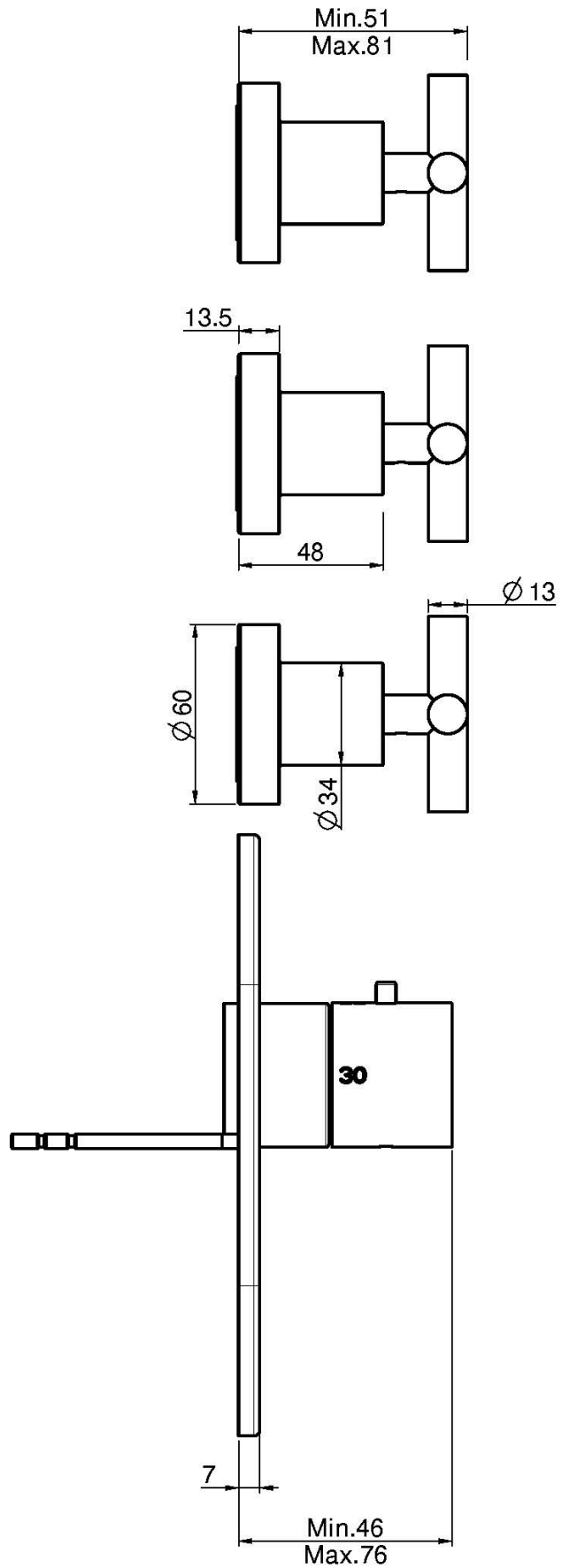
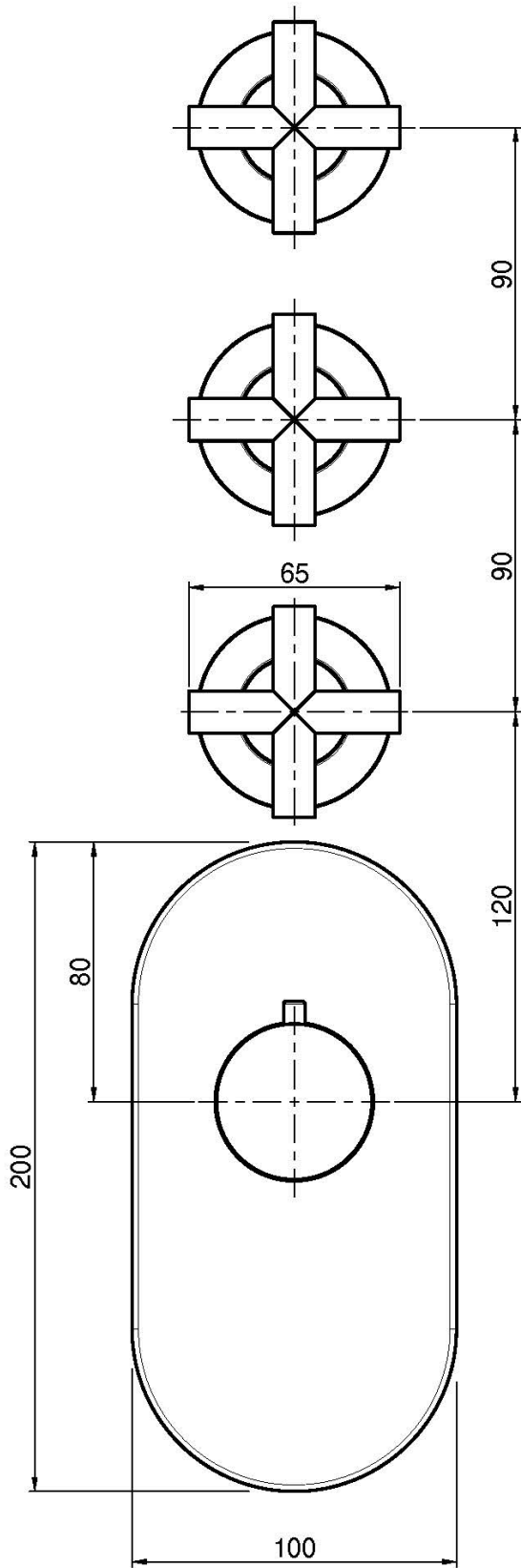

This drawing is the property of FIMA Carlo Frattini. Any complete or partial reproduction, or any transmission to third party without FIMA Carlo Frattini authorization is forbidden.

