

Codigo F2690

TOMA DE AGUA 1/2"

IMAGEN



Acabados

-  CROMADO
CR
-  HL
-  HS
-  ZL
-  ZS
-  NÍQUEL SATINADO
SN
-  CROMO NEGRO
CN
-  CROMO NEGRO SATINADO
CS
-  BLANCO MATE
BS
-  NEGRO MATE
NS
-  DORADO
OR
-  ORO SATINADO
OS



Consulte las condiciones generales de venta en nuestra lista
de precios aplicable

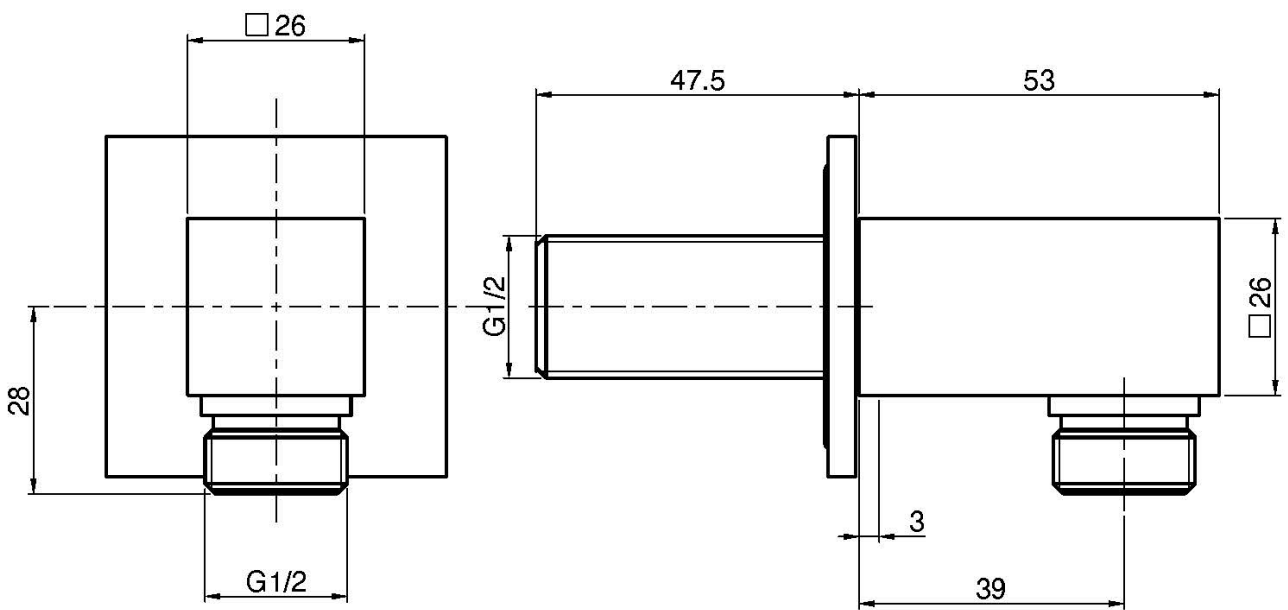

This drawing is the property of FIMA Carlo Frattini. Any complete or partial reproduction, or any transmission to third party without FIMA Carlo Frattini authorization is forbidden.