







Code F4169X2

MITIGEUR BAIN/DOUCHE MÉCANIQUE ENCASTRÉ AVEC INVERSEUR À 2 SORTIES

- habillage pour corps encastrable
- inverseur
- **corps encastrable à commander séparément**

Finitions

-  CHROMÉ
CR
-  HL
-  HS
-  NICKEL BROSSÉ
SN
-  CHROMÉ NOIR
CN
-  CHROMÉ NOIR BROSSÉ
CS

IMAGE



PRODUITS À COMMANDER SÉPARÉMENT

[Corps encastrable](#)



Voir les conditions générales de vente dans notre tarif en
vigueur

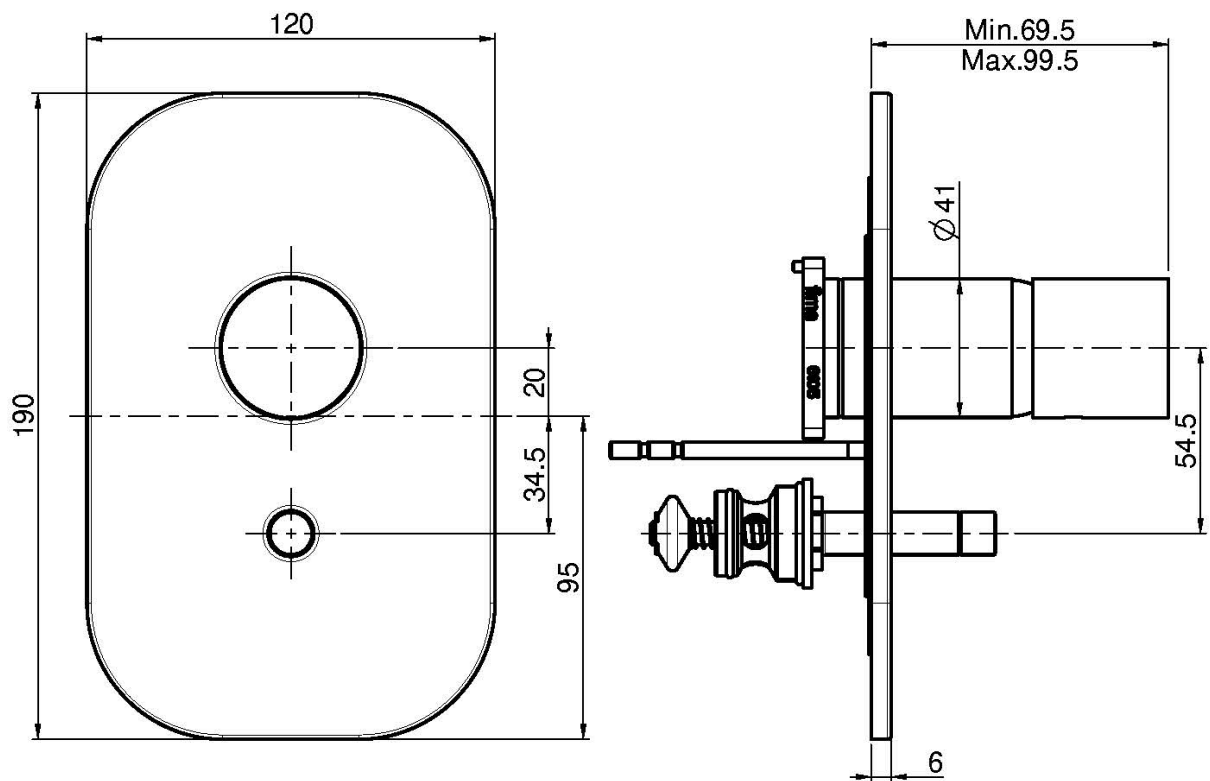

This drawing is the property of FIMA Carlo Frattini. Any complete or partial reproduction, or any transmission to third party without FIMA Carlo Frattini authorization is forbidden.

