

Code F5009X2

## MITIGEUR BAIN/DOUCHE MÉCANIQUE ENCASTRÉ AVEC INVERSEUR À 2 SORTIES

- habillage pour corps encastrable
- rosace en métal
- inverseur
- **corps encastrable à commander séparément**

## Finitions

-  CHROMÉ  
CR
-  NICKEL BROSSÉ  
SN
-  DORÉ  
OR
-  DORÉ BROSSÉ  
OS
-  VIEUX BRONZE  
BR
-  ANTIQUE COPPER  
RA

## IMAGE



## PRODUITS À COMMANDER SÉPARÉMENT

### [Corps encastrable](#)



Voir les conditions générales de vente dans notre tarif en vigueur

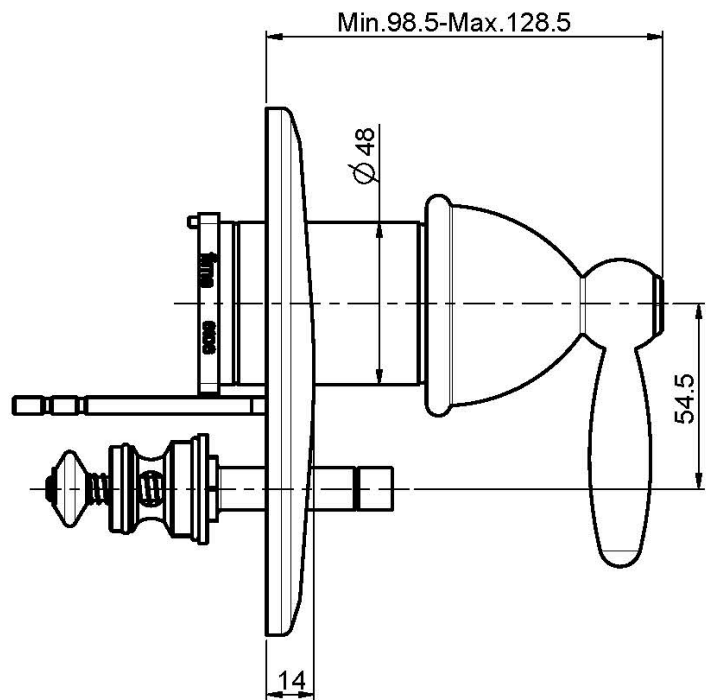
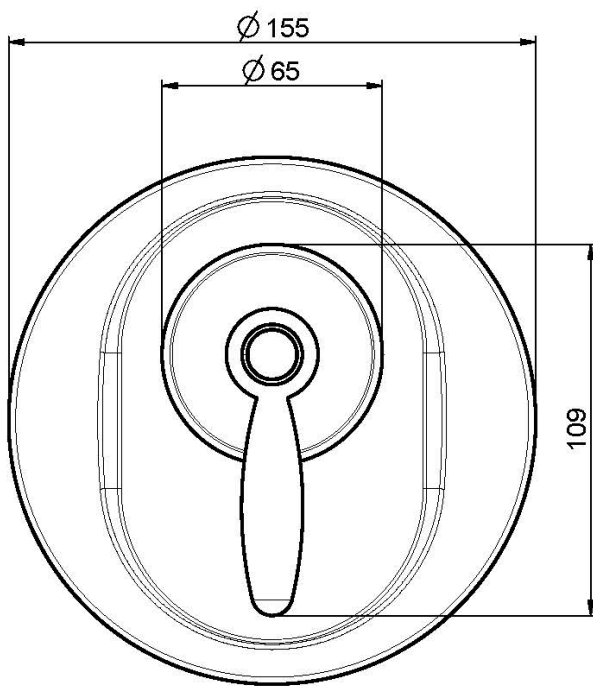

This drawing is the property of FIMA Carlo Frattini. Any complete or partial reproduction, or any transmission to third party without FIMA Carlo Frattini authorization is forbidden.

