

Code F5089X2

MITIGEUR BAIN/DOUCHE MÉCANIQUE ENCASTRÉ AVEC INVERSEUR À 2 SORTIES

- habillage pour corps encastrable
- rosace en métal
- inverseur
- **corps encastrable à commander séparément**

Finitions

-  CHROMÉ
CR
-  NICKEL BROSSÉ
SN
-  DORÉ
OR
-  DORÉ BROSSÉ
OS
-  VIEUX BRONZE
BR
-  ANTIQUE COPPER
RA

IMAGE



PRODUITS À COMMANDER SÉPARÉMENT

[Corps encastrable](#)



Voir les conditions générales de vente dans notre tarif en vigueur

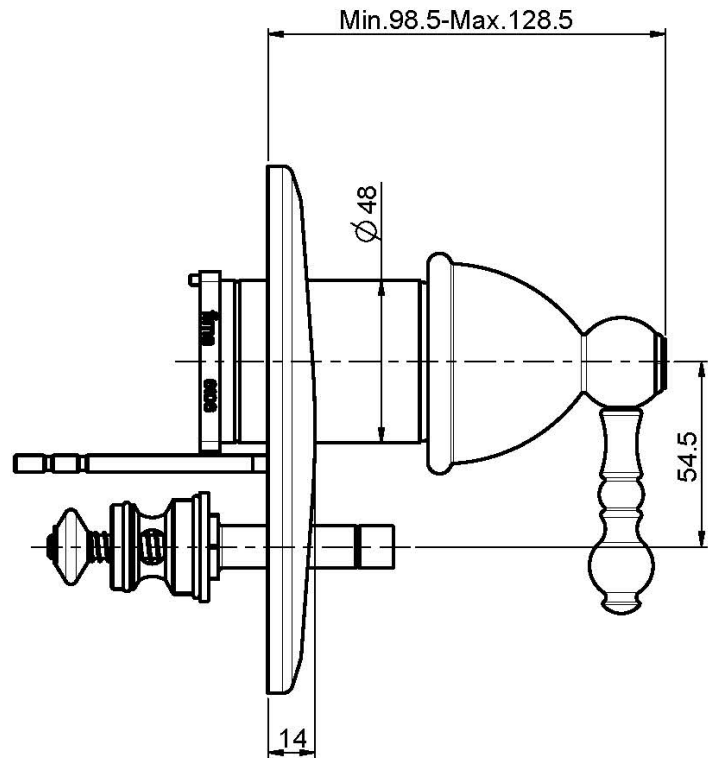
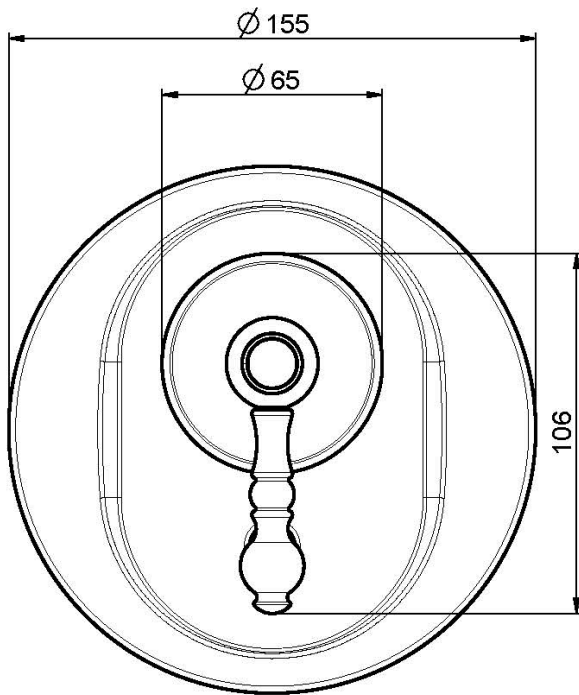

This drawing is the property of FIMA Carlo Frattini. Any complete or partial reproduction, or any transmission to third party without FIMA Carlo Frattini authorization is forbidden.

