

Code F5043X2

## MITIGEUR THERMOSTATIQUE DOUCHE ENCASTRÉ

- installation horizontale ou verticale
- habillage pour corps encastrable
- habillage pour 2 robinets d'arrêt
- poignée avec butée de sécurité à 38°
- **corps encastrable à commander séparément**

## Finitions

-  CHROMÉ  
CR
-  NICKEL BROSSÉ  
SN
-  DORÉ  
OR
-  DORÉ BROSSÉ  
OS
-  VIEUX BRONZE  
BR
-  ANTIQUE COPPER  
RA

## IMAGE



## PRODUITS À COMMANDER SÉPARÉMENT

### [Corps encastrable](#)



Voir les conditions générales de vente dans notre tarif en vigueur

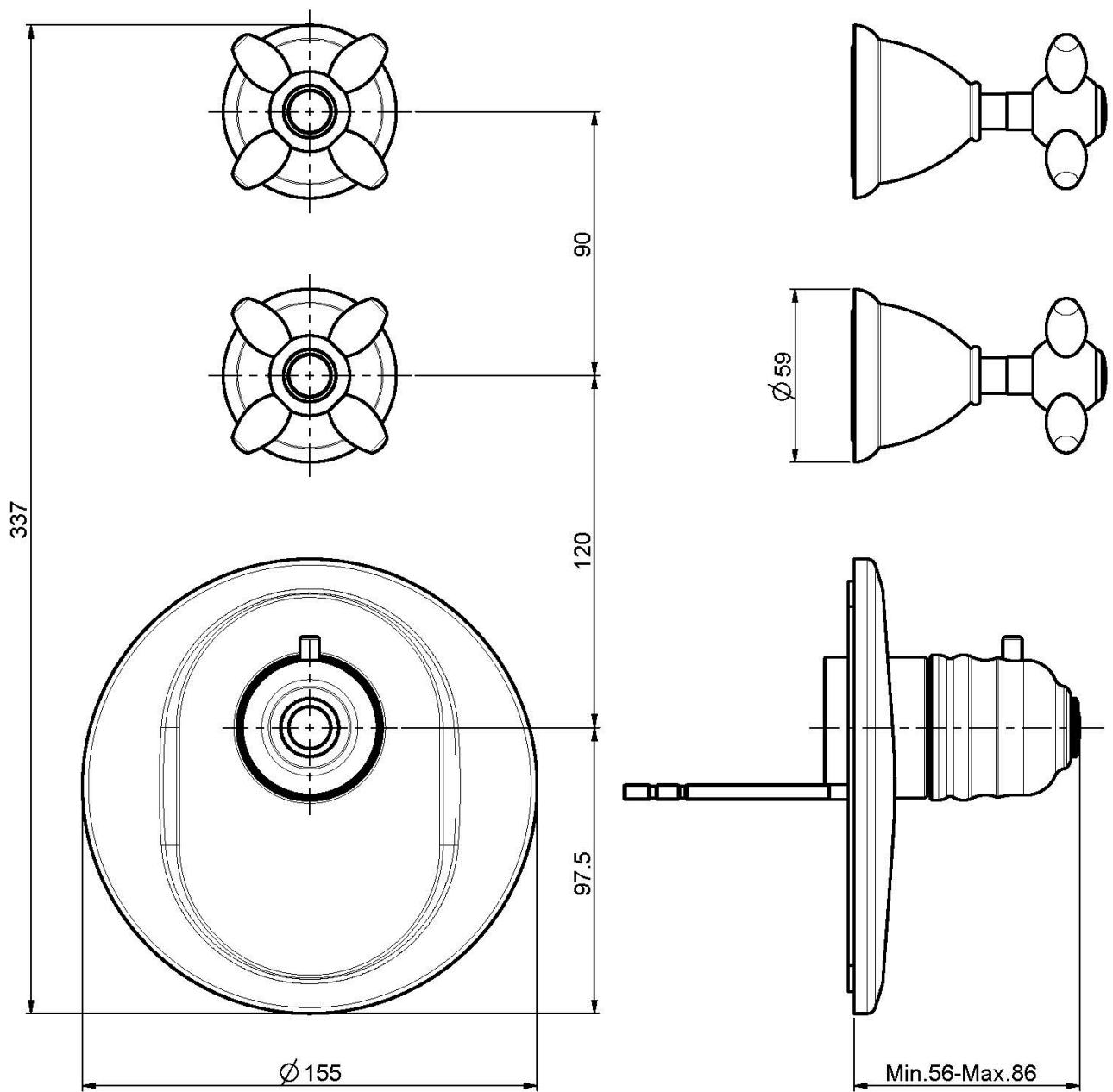

This drawing is the property of FIMA Carlo Frattini. Any complete or partial reproduction, or any transmission to third party without FIMA Carlo Frattini authorization is forbidden.

