

Code F5333X4







MITIGEUR THERMOSTATIQUE DOUCHE ENCASTRÉ

- poignée avec butée de sécurité à 38°
- habillage pour 4 robinets d'arrêt
- habillage pour corps encastrable
- installation horizontale ou verticale
- **corps encastrable à commander séparément**

IMAGE



Finitions

-  CHROMÉ
CR
-  HL
-  HS
-  NICKEL BROSSÉ
SN
-  CHROMÉ NOIR
CN
-  CHROMÉ NOIR BROSSÉ
CS
-  BLANC MAT
BS
-  NOIR MAT
NS

PRODUITS À COMMANDER SÉPARÉMENT

[Corps encastrable](#)



Voir les conditions générales de vente dans notre tarif en vigueur

F5333X4

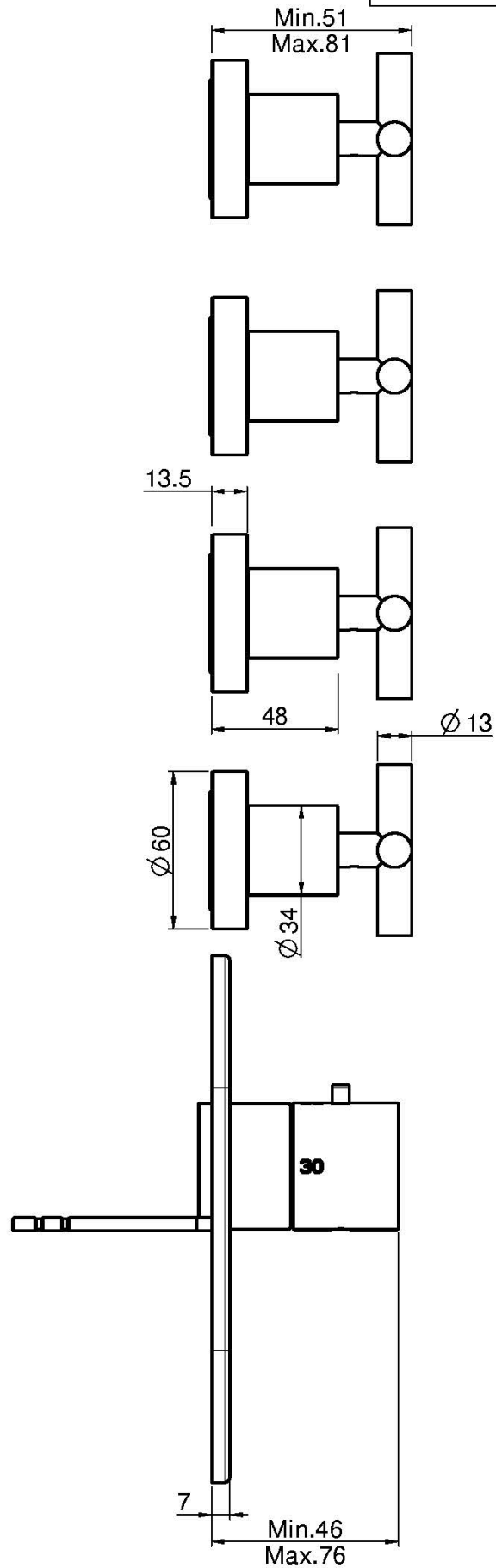
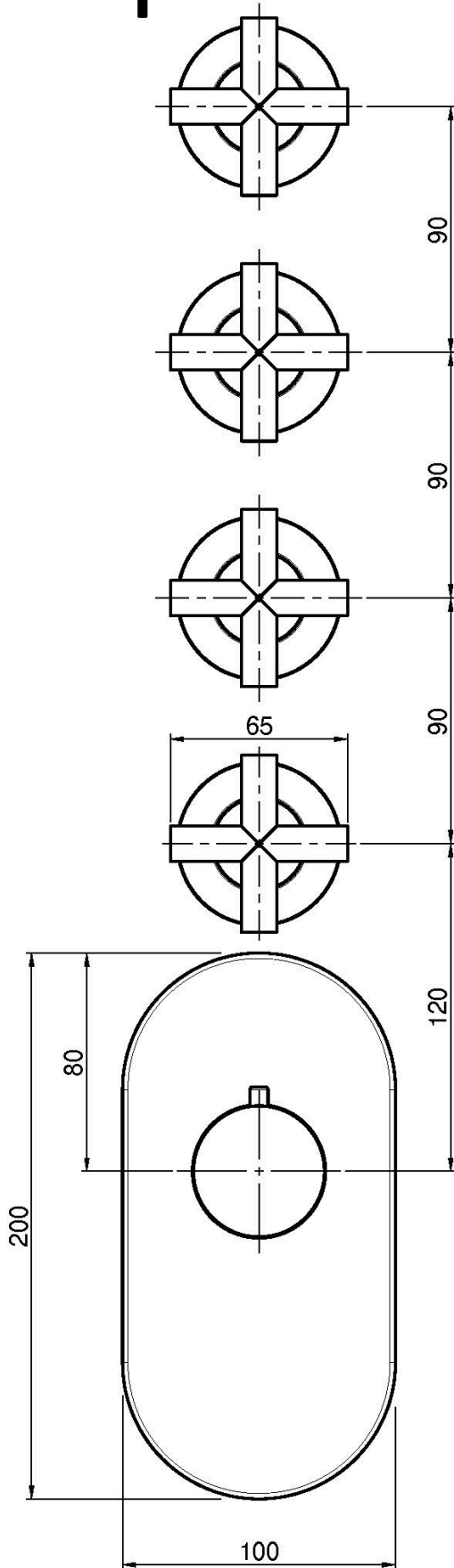

This drawing is the property of FIMA Carlo Frattini. Any complete or partial reproduction, or any transmission to third party without FIMA Carlo Frattini authorization is forbidden.

