

Code F5333X3







## MITIGEUR THERMOSTATIQUE DOUCHE ENCASTRÉ GAMME MAXIMA

- poignée avec butée de sécurité à 38°
- habillage pour 3 robinets d'arrêt
- habillage pour corps encastrable
- installation horizontale ou verticale
- **corps encastrable à commander séparément**

### IMAGE



### Finitions

-  CHROMÉ  
CR
-  HL
-  HS
-  NICKEL BROSSÉ  
SN
-  CHROMÉ NOIR  
CN
-  CHROMÉ NOIR BROSSÉ  
CS
-  BLANC MAT  
BS
-  NOIR MAT  
NS

### PRODUITS À COMMANDER SÉPARÉMENT

#### [Corps encastrable](#)



Voir les conditions générales de vente dans notre tarif en  
vigueur

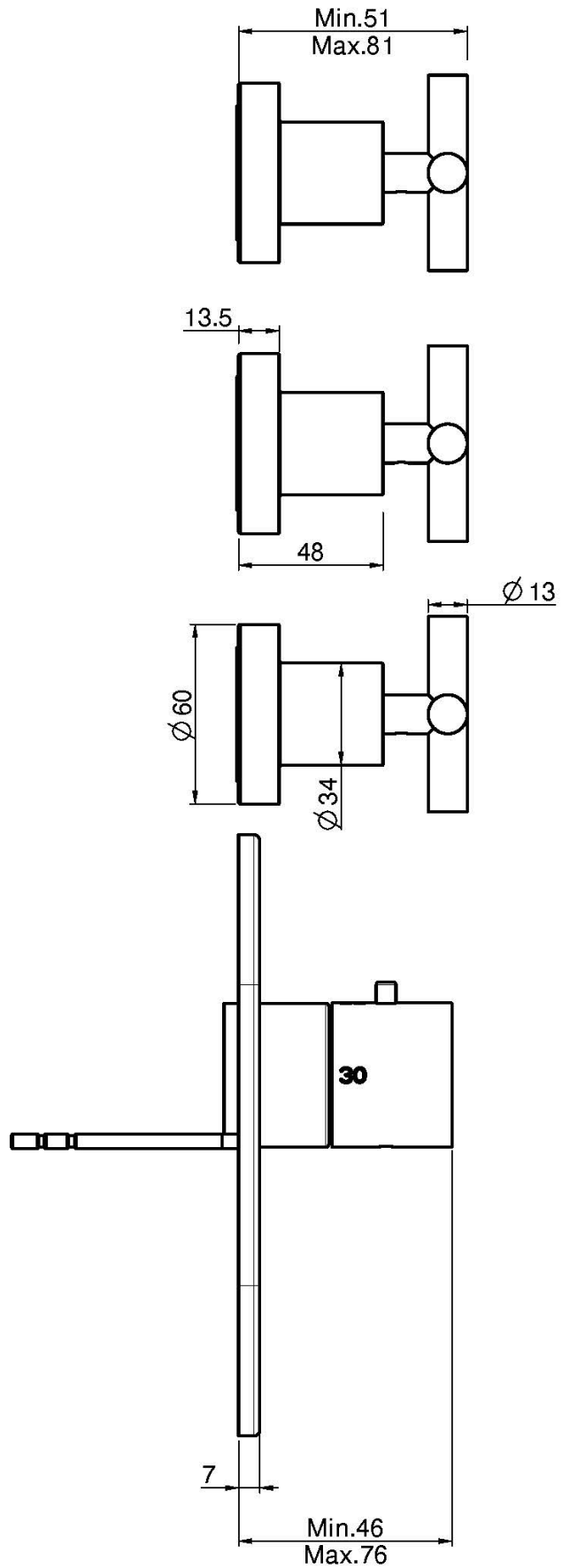
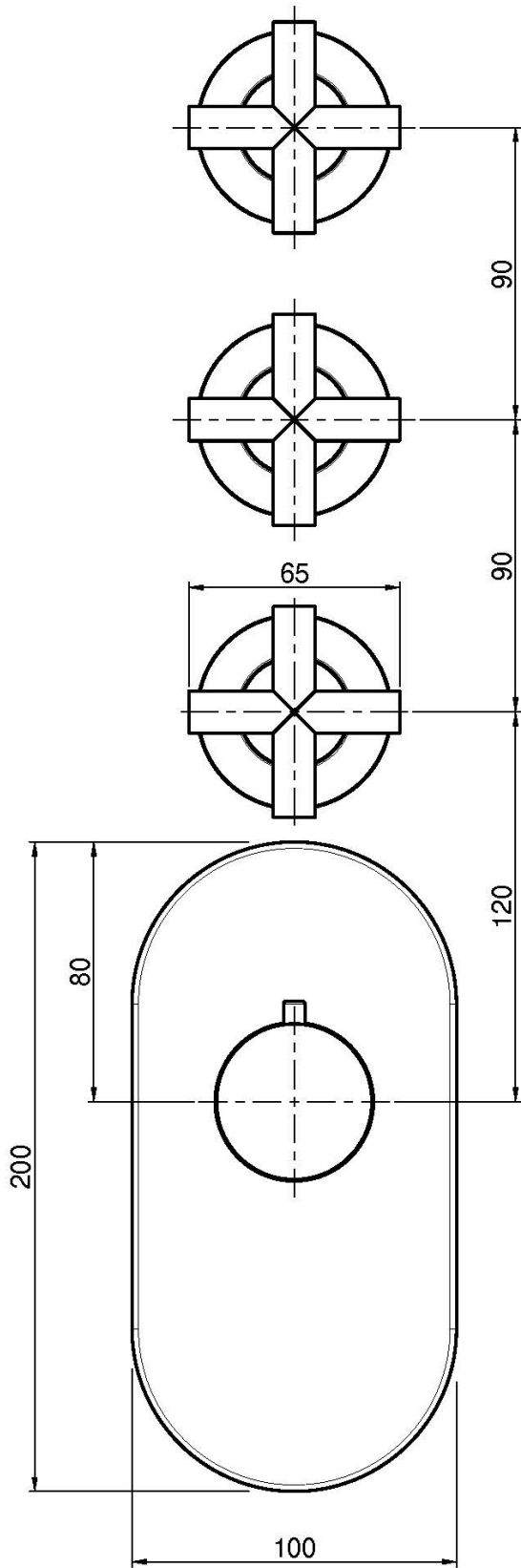

This drawing is the property of FIMA Carlo Frattini. Any complete or partial reproduction, or any transmission to third party without FIMA Carlo Frattini authorization is forbidden.

