

Codice F5005/2

GRUPPO DOCCIA ESTERNO CON COLONNA DOCCIA SOFFIONE E DOCCETTA

- colonna regolabile in altezza
- n.2 raccordi eccentrici 1/2"
- soffione in ottone Ø 200 mm
- flessibile in ottone 1500 mm
- doccia con ugelli anticalcare
- deviatore

Finiture

-  CROMO
CR
-  NICKEL SPAZZOLATO
SN
-  ORO
OR
-  ORO SPAZZOLATO
OS
-  BRONZO
BR
-  RAME ANTICO
RA

IMMAGINE



Vedere le condizioni generali di vendita presenti sul nostro
listino in vigore

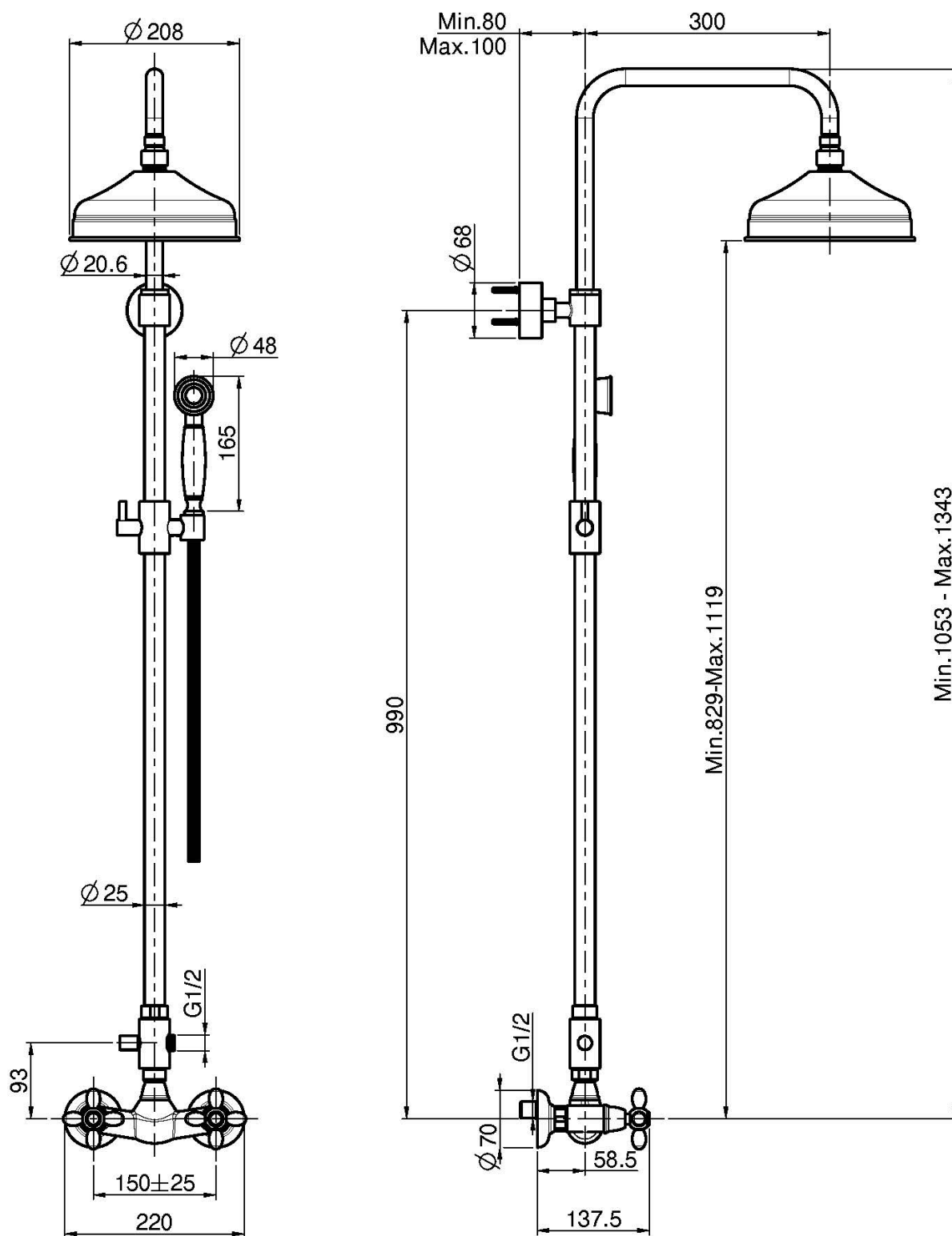

This drawing is the property of FIMA Carlo Frattini. Any complete or partial reproduction, or any transmission to third party without FIMA Carlo Frattini authorization is forbidden.