

Codice F3309X1

MISCELATORE INCASSO DOCCIA

- solo parte esterna
- piastra in metallo
- **corpo incasso da ordinare separatamente**

IMMAGINE



Finiture

-  CROMO
CR
-  NICKEL SPAZZOLATO
SN
-  ORO
OR
-  ORO SPAZZOLATO
OS
-  BRONZO
BR
-  RAME ANTICO
RA

PRODOTTI DA ORDINARE SEPARATAMENTE

[Corpo da incasso](#)



Vedere le condizioni generali di vendita presenti sul nostro
listino in vigore

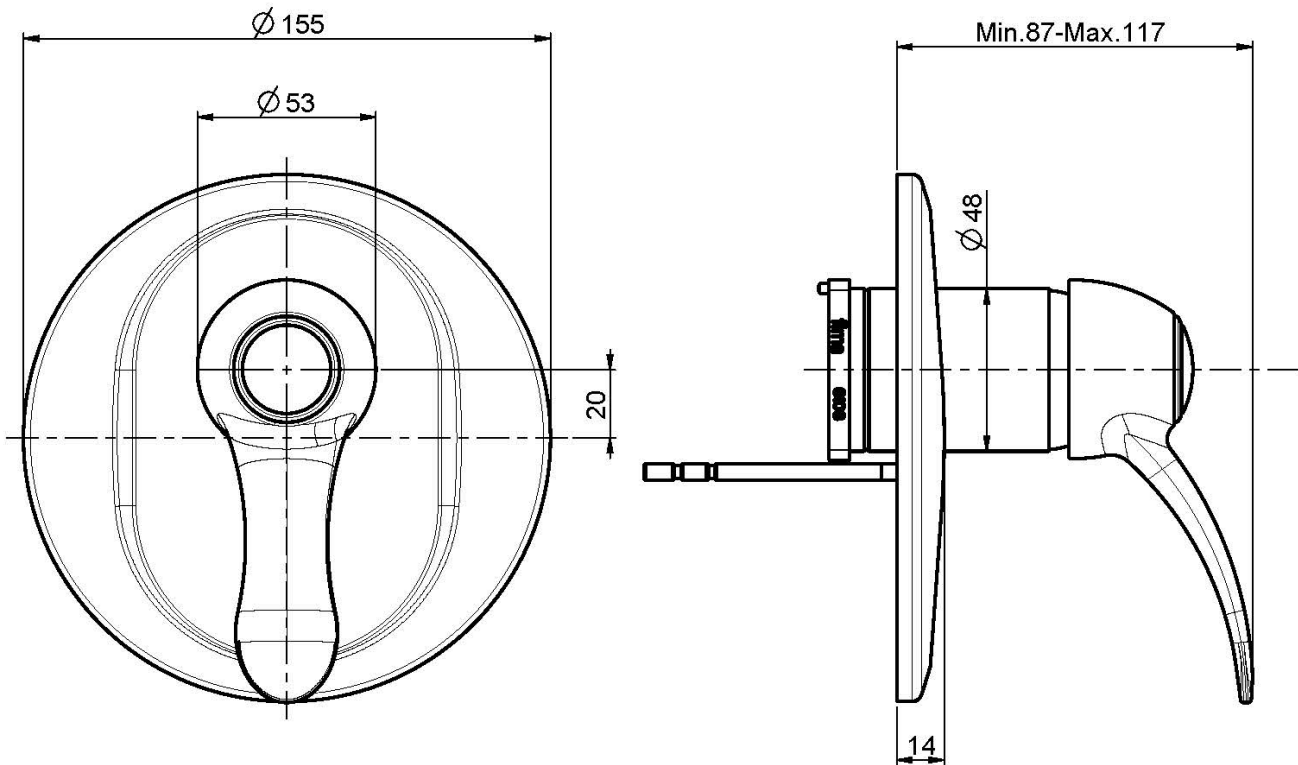

This drawing is the property of FIMA Carlo Frattini. Any complete or partial reproduction, or any transmission to third party without FIMA Carlo Frattini authorization is forbidden.

