

Codice F3833/1

MISCELATORE INCASSO DOCCIA

- solo parte esterna
- **corpo incasso da ordinare separatamente**

Finiture

 CROMO
CR

IMMAGINE



Vedere le condizioni generali di vendita presenti sul nostro
listino in vigore

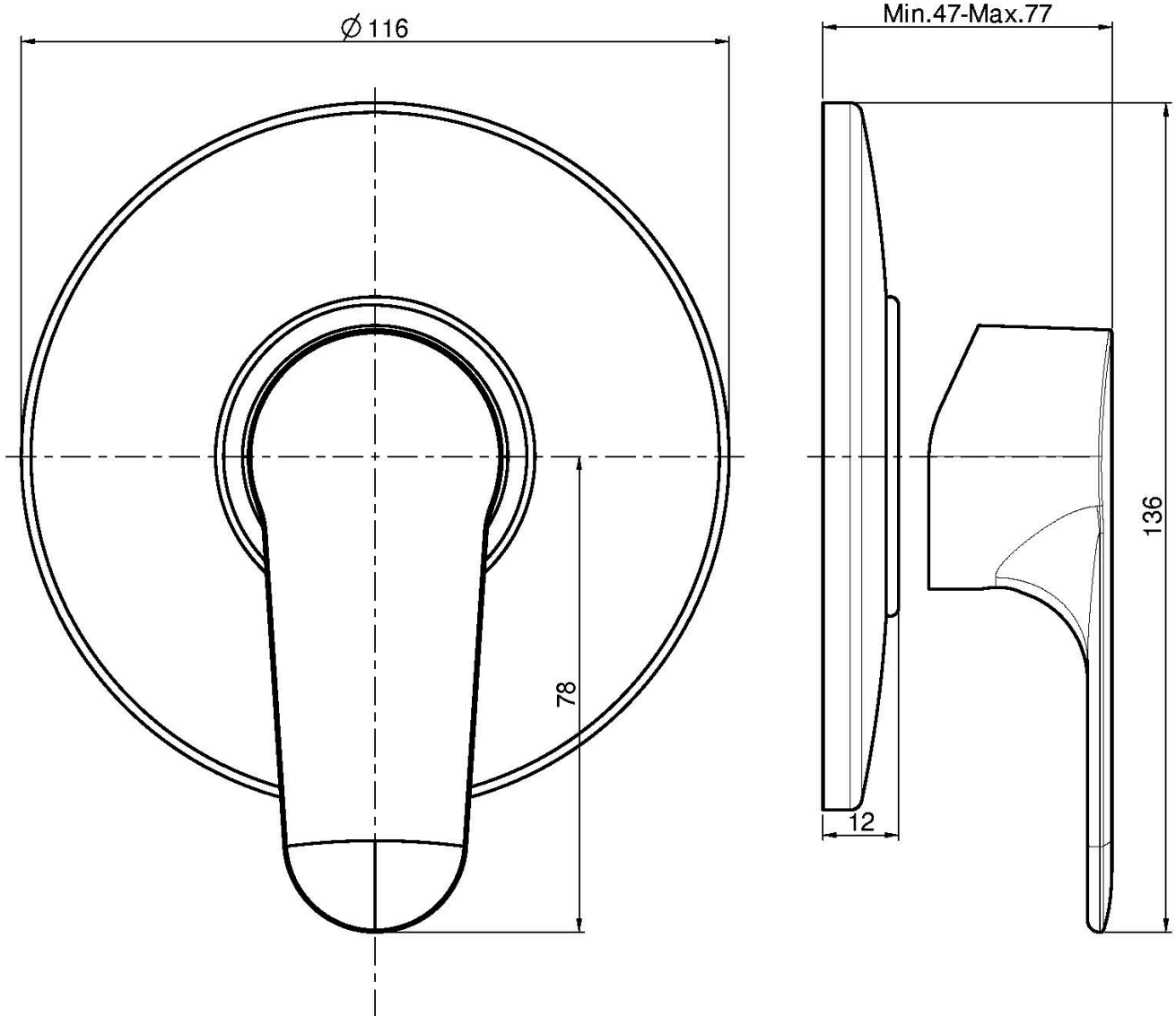

This drawing is the property of FIMA Carlo Frattini. Any complete or partial reproduction, or any transmission to third party without FIMA Carlo Frattini authorization is forbidden.