

Codice F5009X1

## MISCELATORE INCASSO DOCCIA

- solo parte esterna
- piastra in metallo
- **corpo incasso da ordinare separatamente**

## IMMAGINE



## Finiture

-  CROMO  
CR
-  NICKEL SPAZZOLATO  
SN
-  ORO  
OR
-  ORO SPAZZOLATO  
OS
-  BRONZO  
BR
-  RAME ANTICO  
RA

## PRODOTTI DA ORDINARE SEPARATAMENTE

### [Corpo da incasso](#)



Vedere le condizioni generali di vendita presenti sul nostro  
listino in vigore

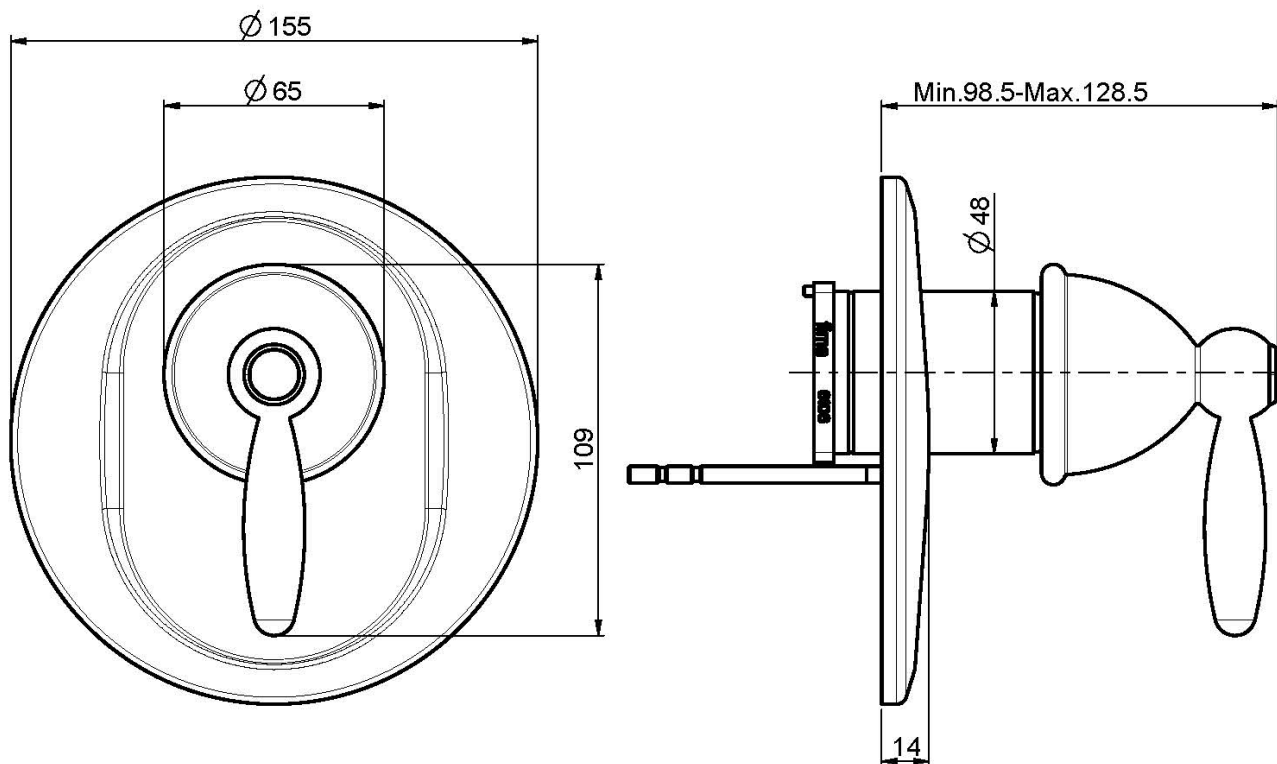

This drawing is the property of FIMA Carlo Frattini. Any complete or partial reproduction, or any transmission to third party without FIMA Carlo Frattini authorization is forbidden.

