

Codice F5113X4

MISCELATORE TERMOSTATICO DA INCASSO

- installazione orizzontale o verticale
- solo parte esterna
- n.4 rubinetti d'arresto
- maniglia graduata con blocco di sicurezza
- **corpo incasso da ordinare separatamente**

Finiture

-  CROMO
CR
-  NICKEL SPAZZOLATO
SN
-  ORO
OR
-  ORO SPAZZOLATO
OS
-  BRONZO
BR
-  RAME ANTICO
RA

IMMAGINE



PRODOTTI DA ORDINARE SEPARATAMENTE

[Corpo da incasso](#)



Vedere le condizioni generali di vendita presenti sul nostro listino in vigore

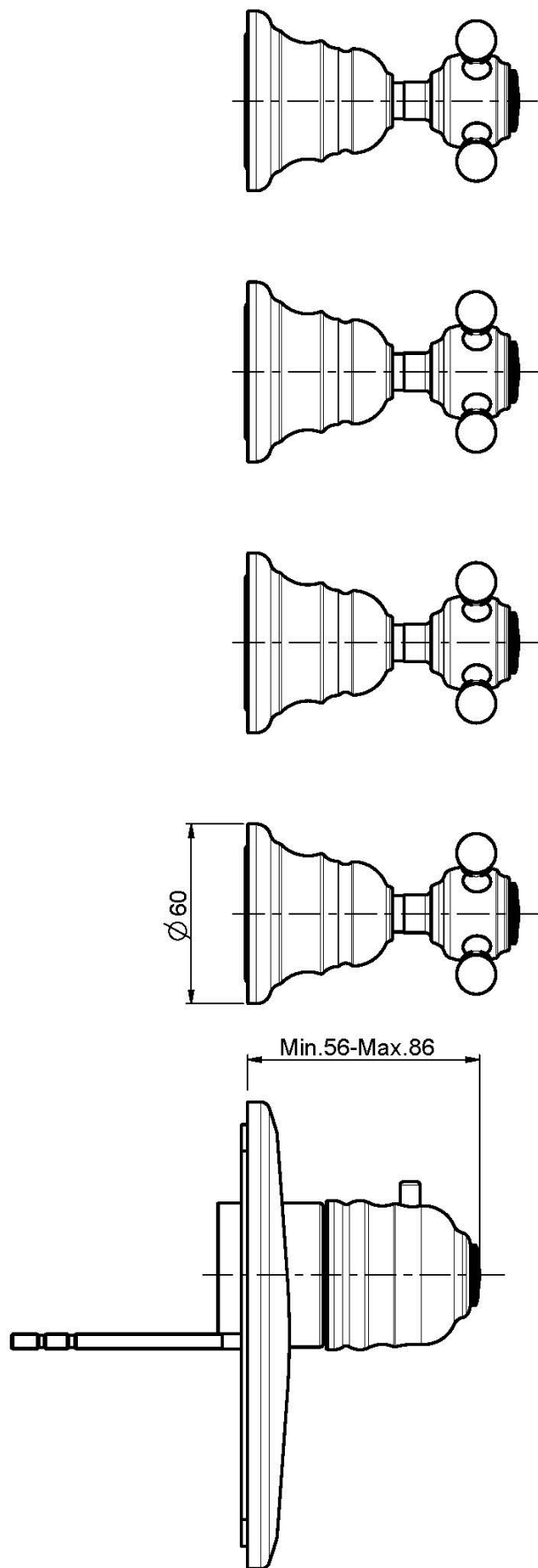
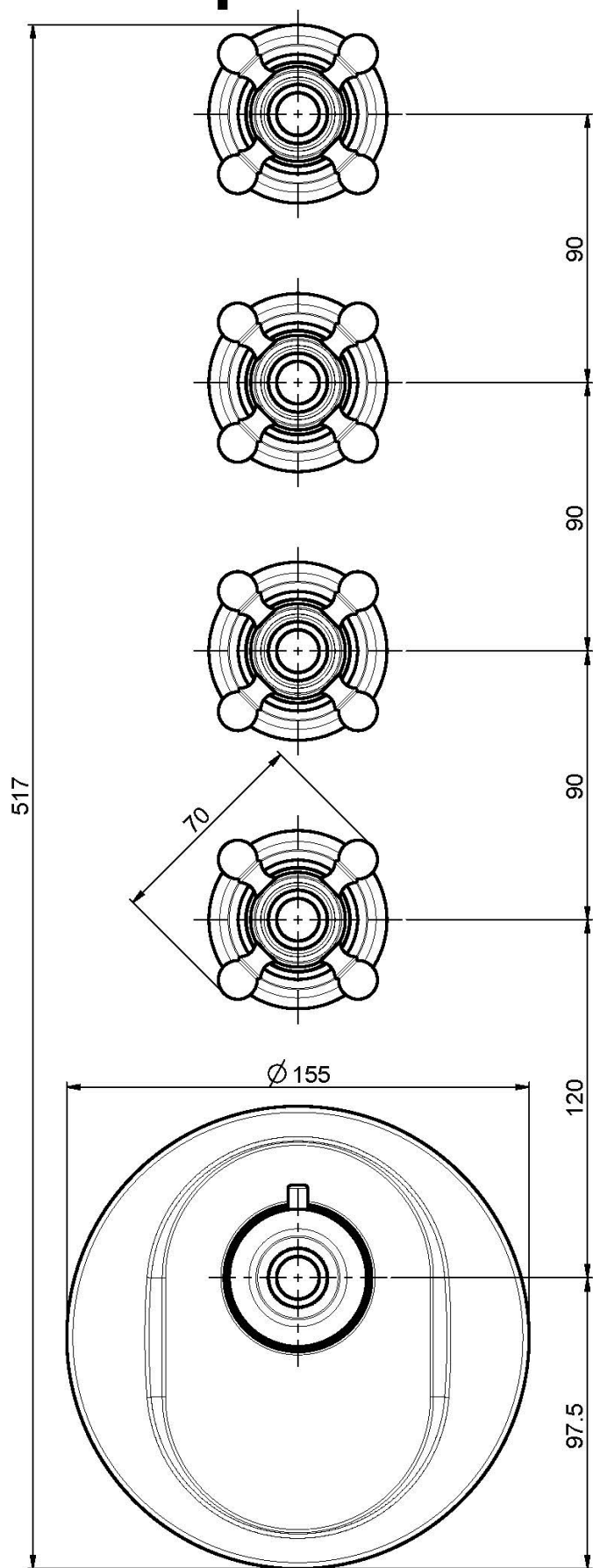

This drawing is the property of FIMA Carlo Frattini. Any complete or partial reproduction, or any transmission to third party without FIMA Carlo Frattini authorization is forbidden.

