

Codice F3253X2

MISCELATORE TERMOSTATICO DA INCASSO

- installazione orizzontale o verticale
- solo parte esterna
- n.2 rubinetti d'arresto
- maniglia graduata con blocco di sicurezza
- **corpo incasso da ordinare separatamente**

IMMAGINE



Finiture

-  CROMO
CR
-  HL
-  HS
-  ZL
-  ZS
-  NICKEL SPAZZOLATO
SN
-  CROMO NERO
CN
-  CROMO NERO SPAZZOLATO
CS
-  BIANCO OPACO
BS
-  NERO OPACO
NS
-  ORO
OR
-  ORO SPAZZOLATO
OS

PRODOTTI DA ORDINARE SEPARATAMENTE

[Corpo da incasso](#)



Vedere le condizioni generali di vendita presenti sul nostro listino in vigore

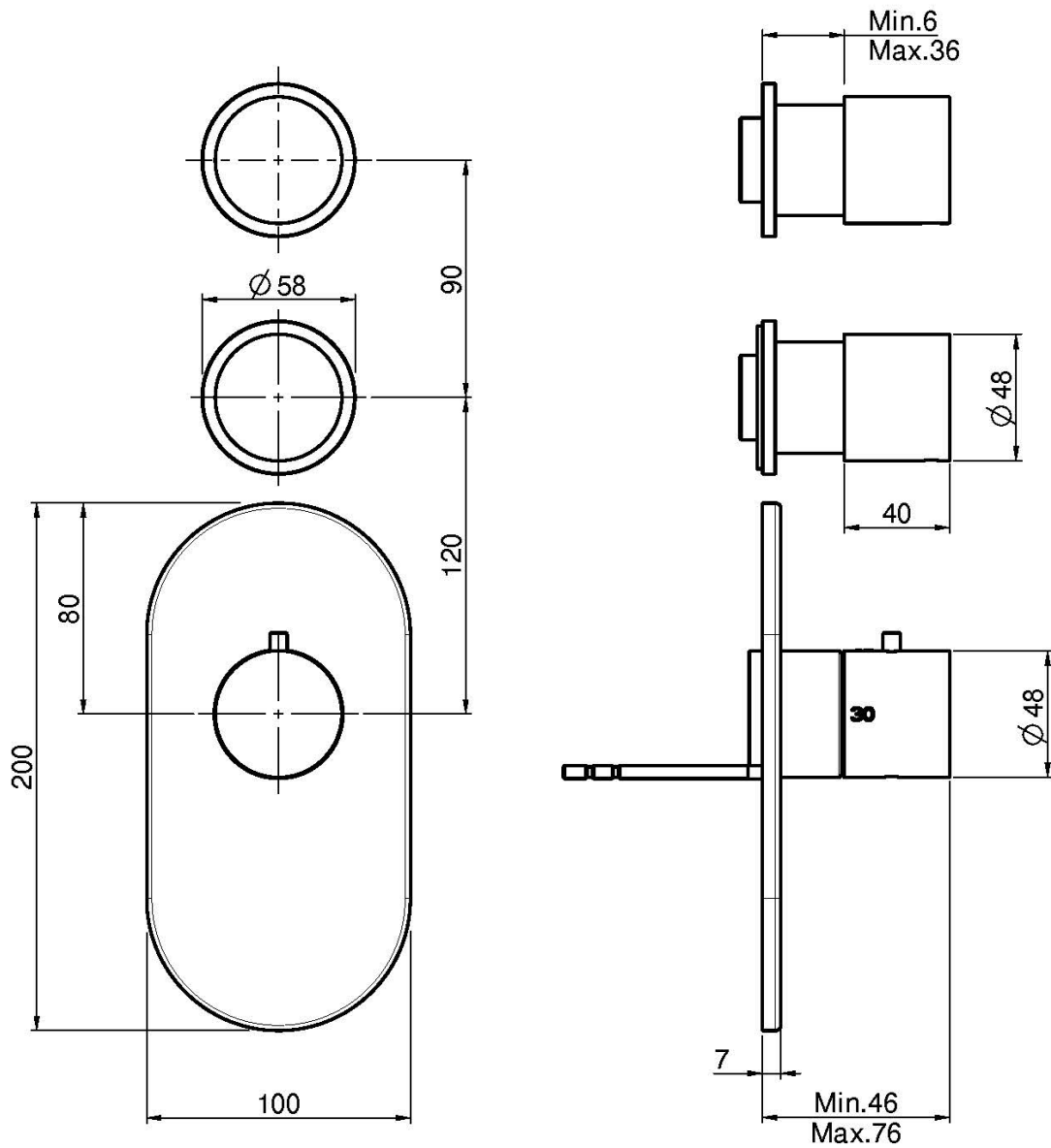

This drawing is the property of FIMA Carlo Frattini. Any complete or partial reproduction, or any transmission to third party without FIMA Carlo Frattini authorization is forbidden.

