

Codice F4885/RP251

**MISCELATORE TERMOSTATICO DOCCIA
ESTERNO CON COLONNA DOCCIA
SOFFIONE E DOCCETTA**

- colonna regolabile in altezza
- n.2 raccordi eccentrici 1/2"
- doccia con ugelli anticalcare
- soffione in ABS Ø 250 mm
- **maniglie in ABS**
- flessibile chromalux 1500 mm
- CORPO FREDDO

Finiture

 CROMO
CR

IMMAGINE



Vedere le condizioni generali di vendita presenti sul nostro
listino in vigore

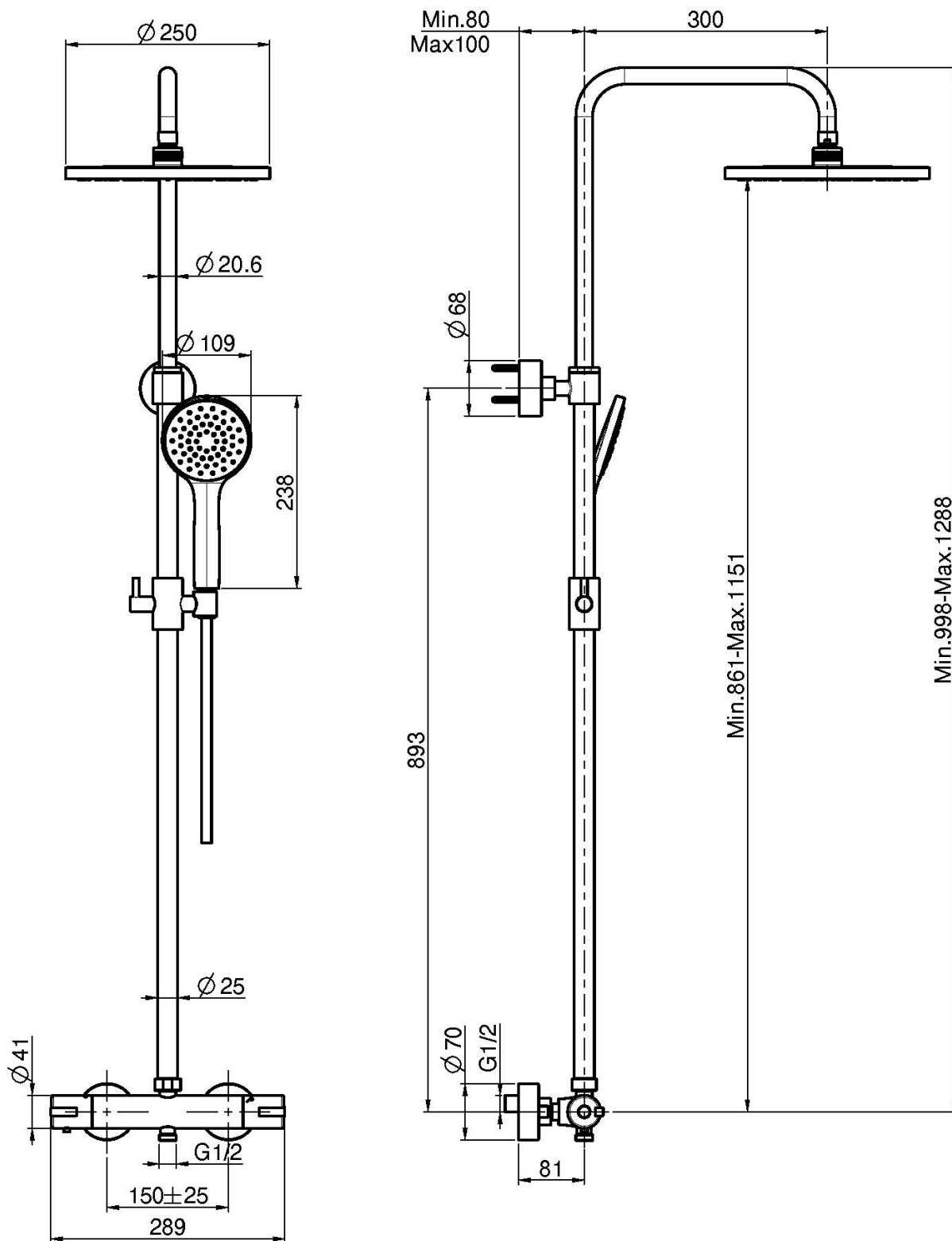

This drawing is the property of FIMA Carlo Frattini. Any complete or partial reproduction, or any transmission to third party without FIMA Carlo Frattini authorization is forbidden.